

Looking ahead,  
going beyond expectations  
*Ahead > Beyond*



**BSP SS - Pompes submersibles en acier inoxydable**

**Databook 50Hz**



# Plage de performances

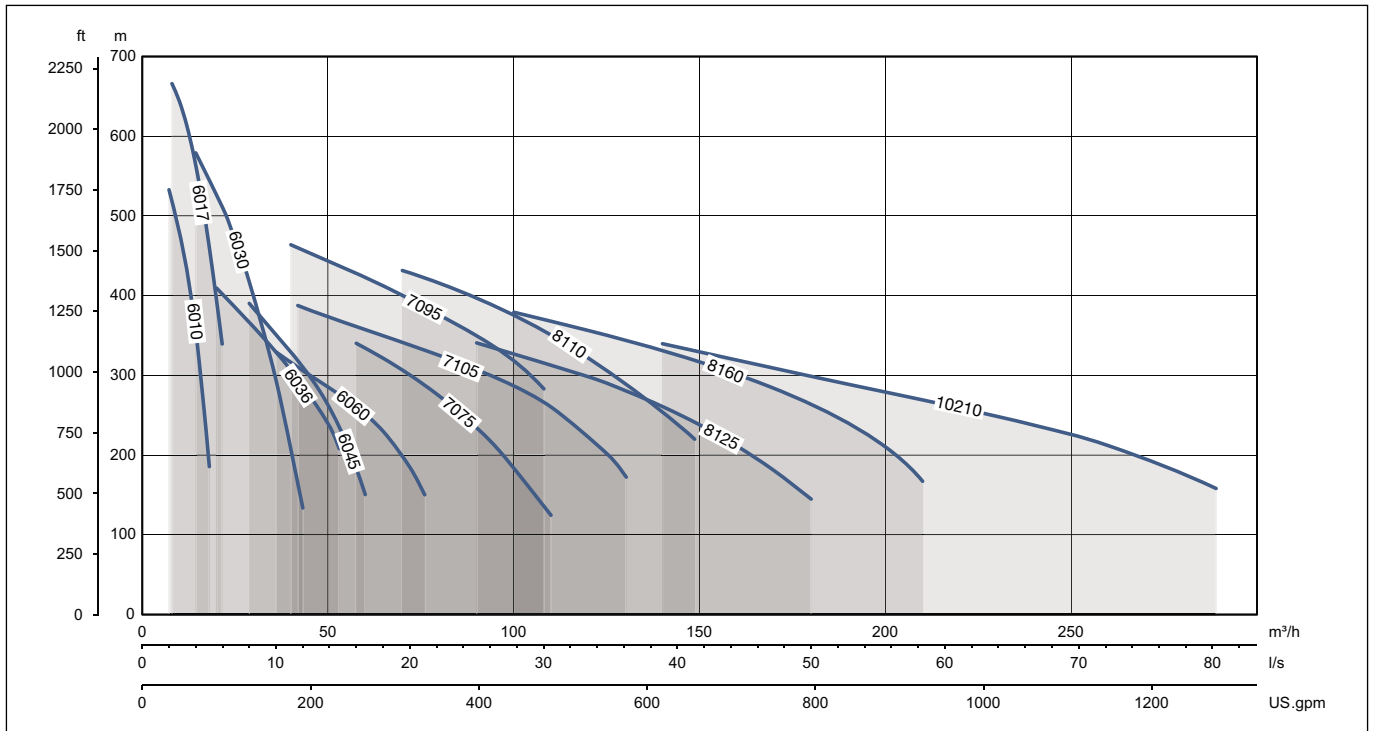

# Sigle d'identification

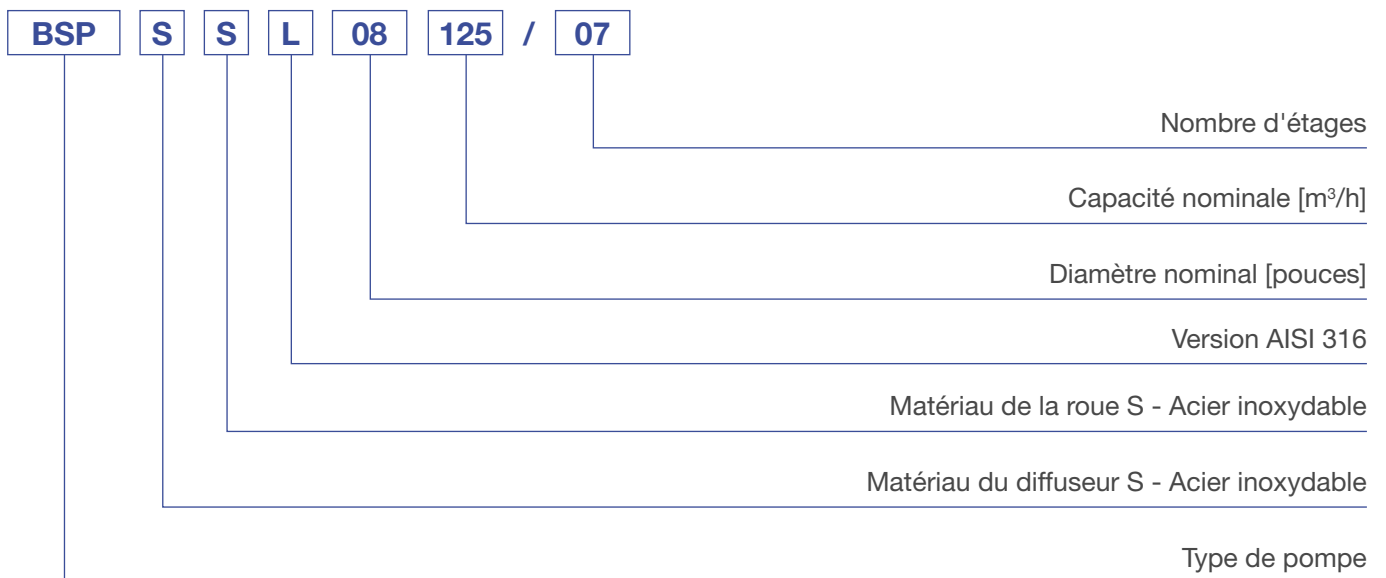

# Informations générales

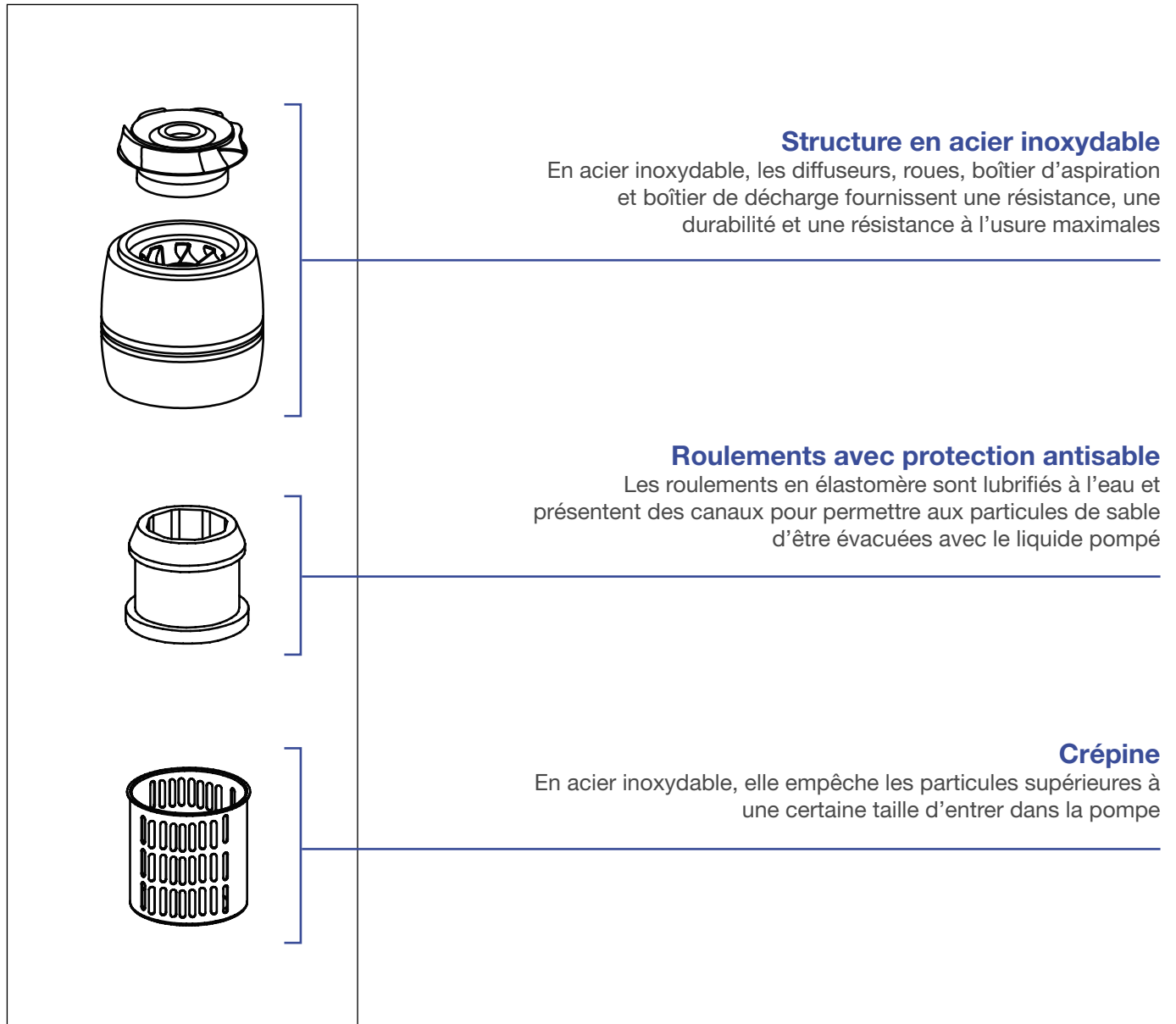

## Principaux avantages

- Longue durée de vie
- Haut rendement
- Durabilité élevée et construction solide
- Entretien facile
- Connexion conforme aux normes NEMA
- Roulement en élastomère lubrifié à l'eau
- Clapet anti-retour intégré

# Vue éclatée

10...60 m<sup>3</sup>/h

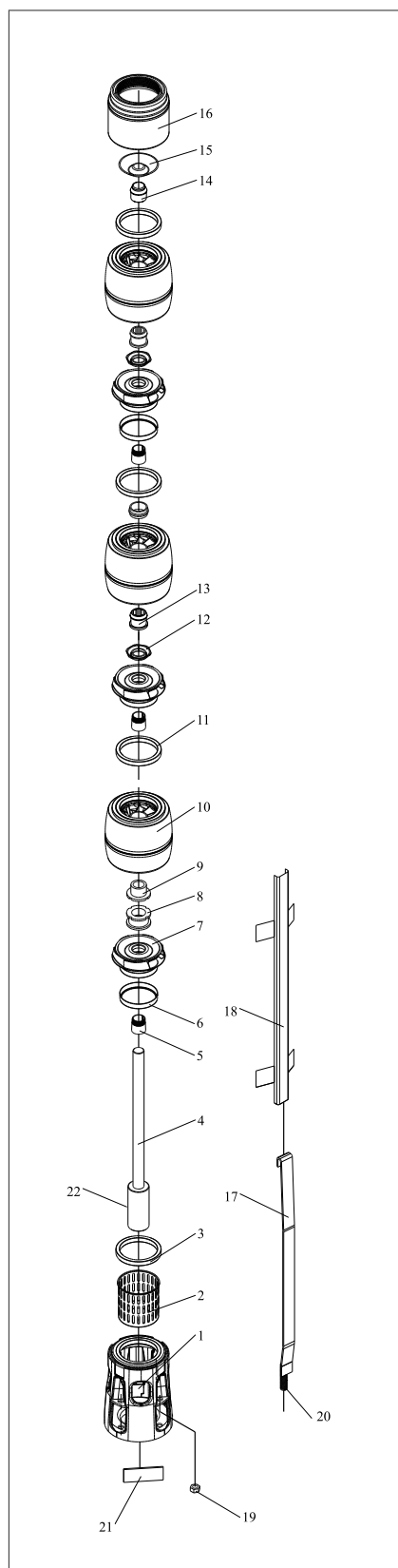

N°	Nom de la pièce	Matériau
1	Boîtier d'aspiration	Acier inoxydable (AISI 304L)
2	Crépine	Acier inoxydable (AISI 304L)
3	Bague d'usure de boîtier d'aspiration	Bronze (ASTM B145-4A)*AISI 304+EPDM
4	Arbre de pompe	Acier inoxydable (AISI 431)
5	Douille de serrage	Acier inoxydable (AISI 304)
6	Bague d'usure de roue	Acier inoxydable (AISI 304L)
7	Roue	Acier inoxydable (AISI 304L)
8	Écrou pour bague de butée	Acier inoxydable (AISI 304)
9	Bague de butée	Bronze (ASTM B145-4A)
10	Diffuseur	Acier inoxydable (AISI 304L)
11	Bague d'usure de diffuseur	EPDM
12	Écrou pour douille de serrage	Acier inoxydable (AISI 304L)
13	Roulement en caoutchouc	EPDM
14	Roulement supérieur	Bronze (ASTM B145-4A)
15	Coupelle de soupape	Acier inoxydable (AISI 304L)
16	Boîtier de décharge	Acier inoxydable (AISI 304L)
17	Tirant	Acier inoxydable (AISI 304L)
18	Protection de câble	Acier inoxydable (AISI 304L)
19	Écrou de tirant	Acier inoxydable (AISI 304)
20	Goujon de tirant	Acier inoxydable (AISI 316)
21	Plaque signalétique	Acier inoxydable (AISI 304L)
22	Joint	Acier inoxydable (AISI 431)

\* Utilisé uniquement pour série BSP SS 06010/06017/06030

# Vue éclatée

75...215 m<sup>3</sup>/h

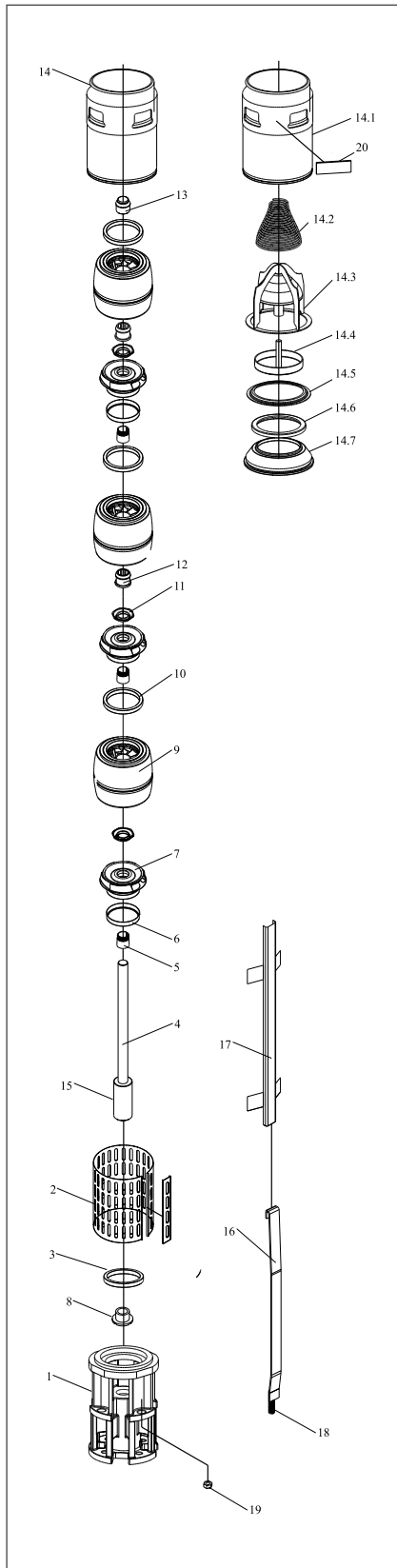

N°	Nom de la pièce	Matériau
1	Boîtier d'aspiration	Acier inoxydable (AISI 304L)
2	Crépine	Acier inoxydable (AISI 304L)
3	Bague d'usure de boîtier d'aspiration	EPDM
4	Arbre de pompe	Acier inoxydable (AISI 431)
5	Douille de serrage	Acier inoxydable (AISI 304)
6	Bague d'usure de roue	Acier inoxydable (AISI 304L)
7	Roue	Acier inoxydable (AISI 304L)
8	Bague de butée	Bronze (ASTM B145-4A)
9	Diffuseur	Acier inoxydable (AISI 304L)
10	Bague d'usure de diffuseur	EPDM
11	Écrou pour douille de serrage	Acier inoxydable (AISI 304L)
12	Roulement en caoutchouc	EPDM
13	Roulement supérieur	Bronze (ASTM B145-4A)
14	Boîtier de décharge	Acier inoxydable (AISI 304L)
14.1	Corps de boîtier de décharge	Acier inoxydable (AISI 304L)
14.2	Ressort de coupelle de soupape	Acier inoxydable (AISI 304L)
14.3	Guide de coupelle de soupape	Acier inoxydable (AISI 304L)
14.4	Coupelle de soupape	Acier inoxydable (AISI 304L)
14.5	Retenue de siège de coupelle de soupape supérieure	Acier inoxydable (AISI 304L)
14.6	Siège de coupelle de soupape	EPDM
14.7	Retenue de siège de coupelle de soupape inférieure	Acier inoxydable (AISI 304L)
15	Joint	Acier inoxydable (AISI 431)
16	Tirant	Acier inoxydable (AISI 304L)
17	Protection de câble	Acier inoxydable (AISI 304L)
18	Goujon de tirant	Acier inoxydable (AISI 316)
19	Écrou de tirant	Acier inoxydable (AISI 304L)
20	Plaque signalétique	Acier inoxydable (AISI 304L)

# 6" BSP SS 06010 01-24

## Courbes de performances

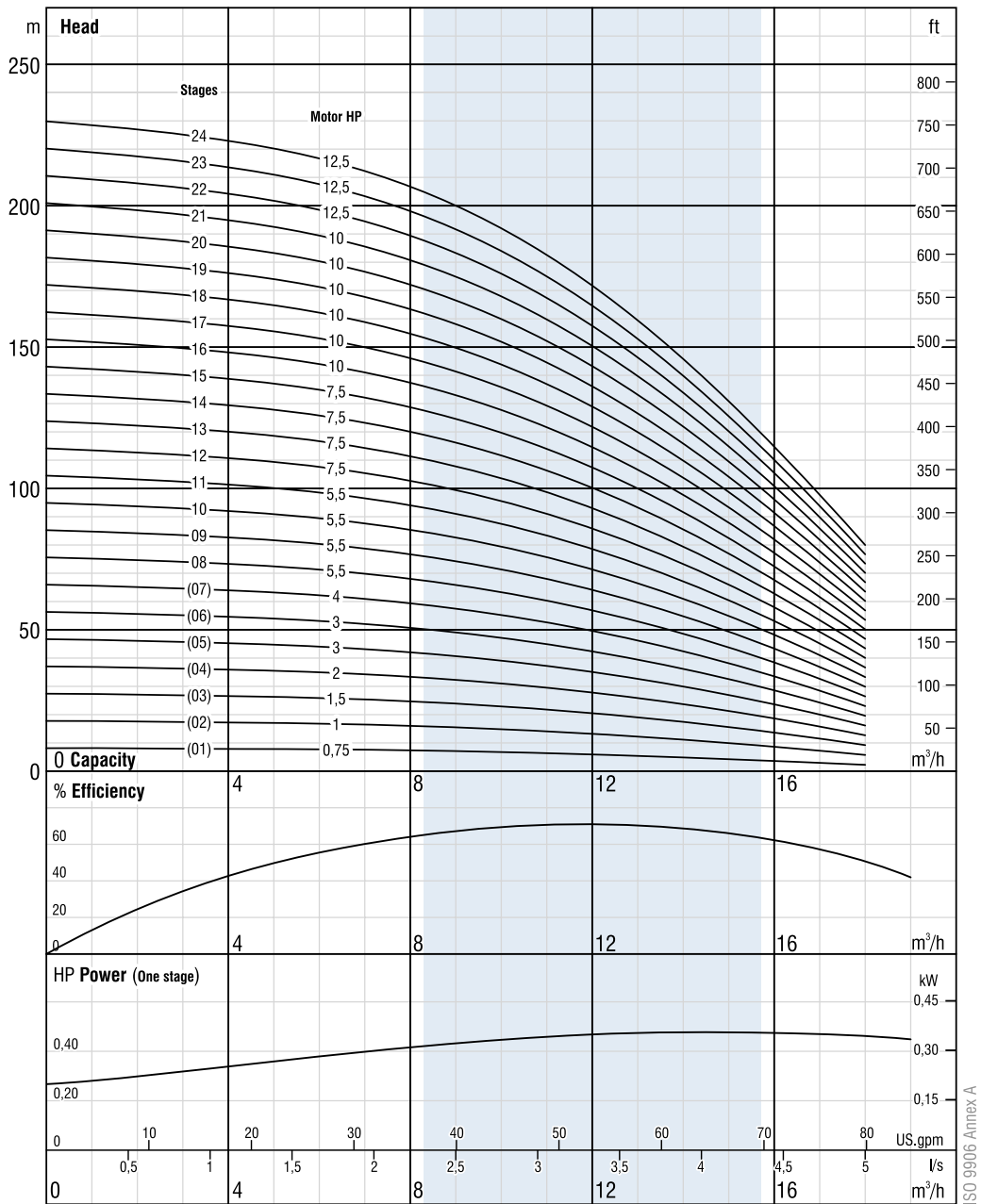

Du fait de l'amélioration continue de la conception, nous nous réservons le droit d'amender les spécifications ou données sans préavis.

# 6" BSP SS 06010 01-24

## Spécifications techniques

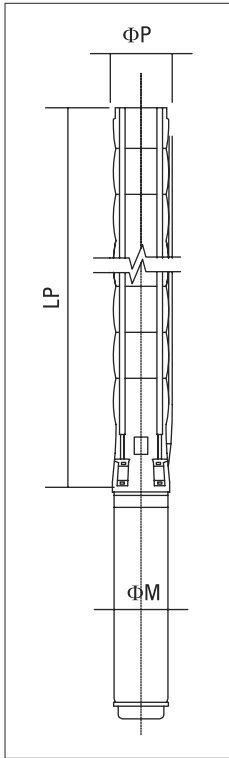

Dimensions							
Modèle	Phases	kW	HP	LP [mm]	ΦM [mm]	ΦP [inch]	Pompe poids [kg]
BSP SS 06010/01	1	0,55	0,75	330	95	6"	5
BSP SS 06010/02	2	0,75	1	390	95	6"	7
BSP SS 06010/03	3	1,1	1,5	451	95	6"	8
BSP SS 06010/04	4	1,5	2	511	95	6"	10
BSP SS 06010/05	5	2,2	3	572	95	6"	11
BSP SS 06010/06	6	2,2	3	632	95	6"	13
BSP SS 06010/07	7	3	4	693	95	6"	14
BSP SS 06010/08	8	4	5,5	753	(95)/142	6"	15
BSP SS 06010/09	9	4	5,5	814	(95)/142	6"	17
BSP SS 06010/10	10	4	5,5	874	(95)/142	6"	18
BSP SS 06010/11	11	4	5,5	935	(95)/142	6"	20
BSP SS 06010/12	12	5,5	7,5	995	(95)/142	6"	21
BSP SS 06010/13	13	5,5	7,5	1056	(95)/142	6"	23
BSP SS 06010/14	14	5,5	7,5	1116	(95)/142	6"	24
BSP SS 06010/15	15	5,5	7,5	1177	(95)/142	6"	26
BSP SS 06010/16	16	7,5	10	1237	(95)/142	6"	27
BSP SS 06010/17	17	7,5	10	1298	(95)/142	6"	28
BSP SS 06010/18	18	7,5	10	1358	(95)/142	6"	30
BSP SS 06010/19	19	7,5	10	1419	(95)/142	6"	31
BSP SS 06010/20	20	7,5	10	1479	(95)/142	6"	33
BSP SS 06010/21	21	7,5	10	1540	(95)/142	6"	34
BSP SS 06010/22	22	9,3	12,5	1600	142	6"	36
BSP SS 06010/23	23	9,3	12,5	1661	142	6"	37
BSP SS 06010/24	24	9,3	12,5	1721	142	6"	39

( ) disponible sur demande

### Tableau de performances

Modèle	Phases	kW	HP	Q=Débit								
				m³/h	0	3,6	7,2	10,8	12,0	14,4	16	18
				l/s	0	1	2	3	3,3	4	4,4	5
H=Hauteur [m]												
BSP SS 06010/01	1	0,55	0,75	8	8	7	6	6	5	4	2	
BSP SS 06010/02	2	0,75	1	17	17	16	14	13	10	8	5	
BSP SS 06010/03	3	1,1	1,5	28	27	26	22	21	17	13	9	
BSP SS 06010/04	4	1,5	2	37	36	34	30	28	22	18	12	
BSP SS 06010/05	5	2,2	3	47	46	43	38	35	28	23	16	
BSP SS 06010/06	6	2,2	3	57	55	52	45	42	34	28	19	
BSP SS 06010/07	7	3	4	66	64	61	53	49	40	33	22	
BSP SS 06010/08	8	4	5,5	77	75	70	62	57	47	38	27	
BSP SS 06010/09	9	4	5,5	86	84	79	69	64	53	43	30	
BSP SS 06010/10	10	4	5,5	96	93	88	77	72	58	48	33	
BSP SS 06010/11	11	4	5,5	105	103	97	85	79	64	53	37	
BSP SS 06010/12	12	5,5	7,5	115	112	106	92	86	70	58	40	
BSP SS 06010/13	13	5,5	7,5	124	121	115	100	93	76	62	43	
BSP SS 06010/14	14	5,5	7,5	134	130	123	108	100	82	67	47	
BSP SS 06010/15	15	5,5	7,5	144	140	132	115	107	88	72	50	
BSP SS 06010/16	16	7,5	10	153	149	141	123	115	93	77	53	
BSP SS 06010/17	17	7,5	10	163	158	150	131	122	99	82	57	
BSP SS 06010/18	18	7,5	10	172	168	159	138	129	105	86	60	
BSP SS 06010/19	19	7,5	10	182	177	167	146	136	111	91	63	
BSP SS 06010/20	20	7,5	10	191	186	176	154	143	117	96	67	
BSP SS 06010/21	21	7,5	10	201	196	185	162	150	123	101	70	
BSP SS 06010/22	22	9,3	12,5	210	205	194	169	157	128	105	73	
BSP SS 06010/23	23	9,3	12,5	220	214	203	177	165	134	110	77	
BSP SS 06010/24	24	9,3	12,5	230	224	211	185	172	140	115	80	

( ) disponible sur demande

# 6" BSP SS 06010 25-42

## Courbes de performances

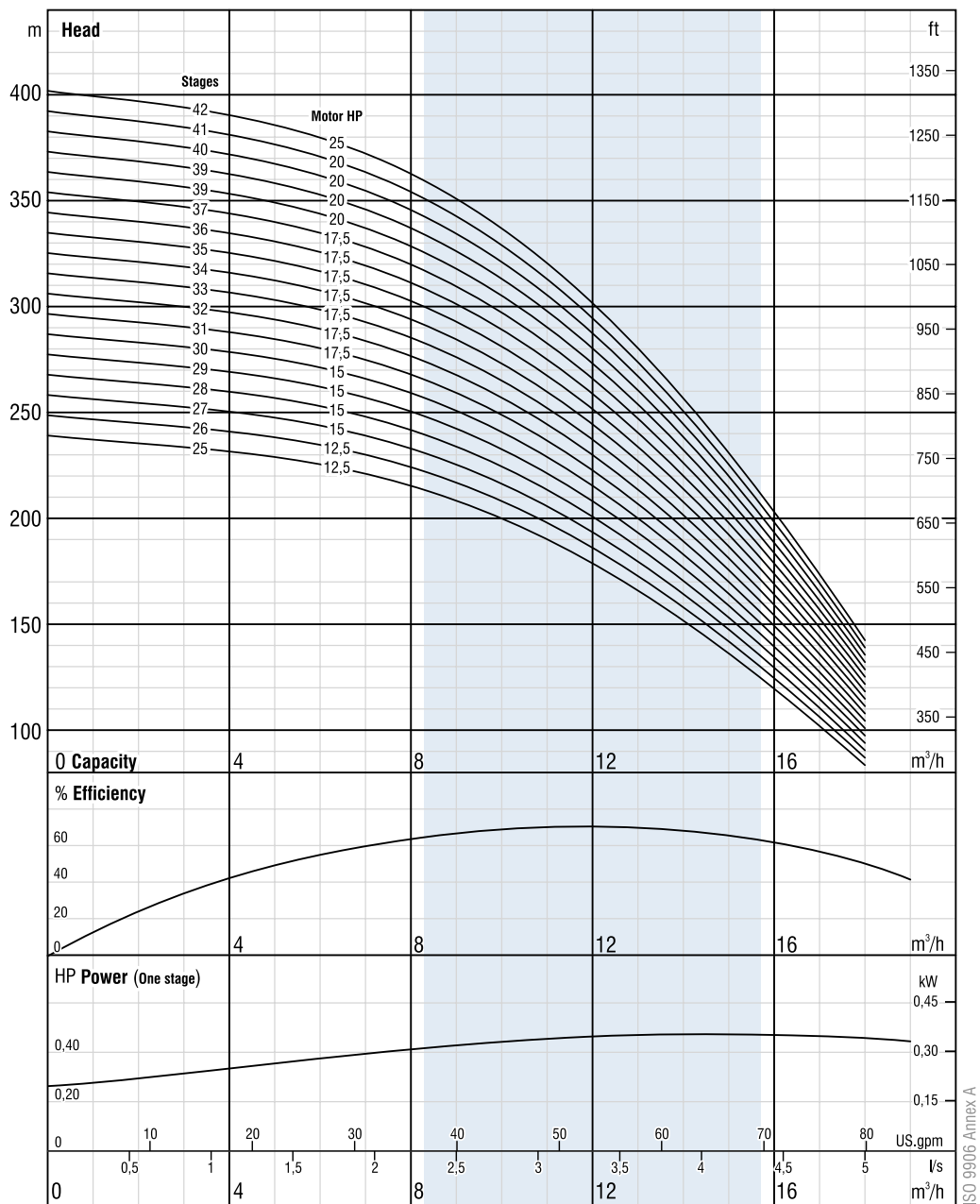

Du fait de l'amélioration continue de la conception, nous nous réservons le droit d'amender les spécifications ou données sans préavis.

ISO 9906 Annex A



# 6" BSP SS 06010 25-42

## Spécifications techniques

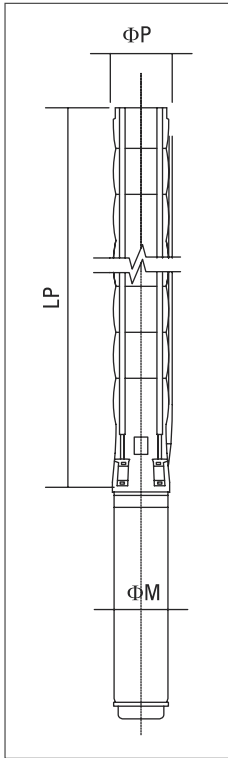

### Dimensions

Modèle	Phases	kW	HP	LP [mm]	ΦM [mm]	ΦP [inch]	Pompe poids [kg]
BSP SS 06010/25	25	9,3	12,5	1782	142	6"	40
BSP SS 06010/26	26	9,3	12,5	1842	142	6"	41
BSP SS 06010/27	27	11	15	1903	142	6"	43
BSP SS 06010/28	28	11	15	1963	142	6"	44
BSP SS 06010/29	29	11	15	2024	142	6"	46
BSP SS 06010/30	30	11	15	2084	142	6"	47
BSP SS 06010/31	31	13	17,5	2145	142	6"	49
BSP SS 06010/32	32	13	17,5	2205	142	6"	50
BSP SS 06010/33	33	13	17,5	2266	142	6"	52
BSP SS 06010/34	34	13	17,5	2326	142	6"	53
BSP SS 06010/35	35	13	17,5	2387	142	6"	54
BSP SS 06010/36	36	13	17,5	2447	142	6"	56
BSP SS 06010/37	37	13	17,5	2508	142	6"	57
BSP SS 06010/38	38	15	20	2568	142	6"	59
BSP SS 06010/39 (*)	39	15	20	2879	142	6"	91
BSP SS 06010/40 (*)	40	15	20	2939	142	6"	92
BSP SS 06010/41 (*)	41	15	20	3000	142	6"	94
BSP SS 06010/42 (*)	42	18,5	25	3060	142	6"	96

\* Version Tandem

### Tableau de performances

Modèle	Phases	kW	HP	Q=Débit								
				m³/h	0	3,6	7,2	10,8	12,0	14,4	16	18
				l/s	0	1	2	3	3,3	4	4,4	5
H=Hauteur [m]												
BSP SS 06010/25	25	9,3	12,5		239	233	220	192	179	146	120	83
BSP SS 06010/26	26	9,3	12,5		249	242	229	200	186	152	125	87
BSP SS 06010/27	27	11	15		258	252	238	208	193	158	129	90
BSP SS 06010/28	28	11	15		268	261	247	215	200	164	134	93
BSP SS 06010/29	29	11	15		277	270	256	223	208	169	139	97
BSP SS 06010/30	30	11	15		287	280	264	231	215	175	144	100
BSP SS 06010/31	31	13	17,5		297	289	273	239	222	181	149	103
BSP SS 06010/32	32	13	17,5		306	298	282	246	229	187	153	107
BSP SS 06010/33	33	13	17,5		316	308	291	254	236	193	158	110
BSP SS 06010/34	34	13	17,5		325	317	300	262	243	199	163	113
BSP SS 06010/35	35	13	17,5		335	326	308	269	251	204	168	117
BSP SS 06010/36	36	13	17,5		344	336	317	277	258	210	173	120
BSP SS 06010/37	37	13	17,5		354	345	326	285	265	216	177	124
BSP SS 06010/38	38	15	20		364	354	335	292	272	222	182	127
BSP SS 06010/39 (*)	39	15	20		373	364	344	300	279	228	187	130
BSP SS 06010/40 (*)	40	15	20		383	373	352	308	286	234	192	134
BSP SS 06010/41 (*)	41	15	20		392	382	361	315	293	239	197	137
BSP SS 06010/42 (*)	42	18,5	25		402	391	370	323	301	245	201	140

\* Version Tandem

# 6" BSP SS 06010 43-53

## Courbes de performances

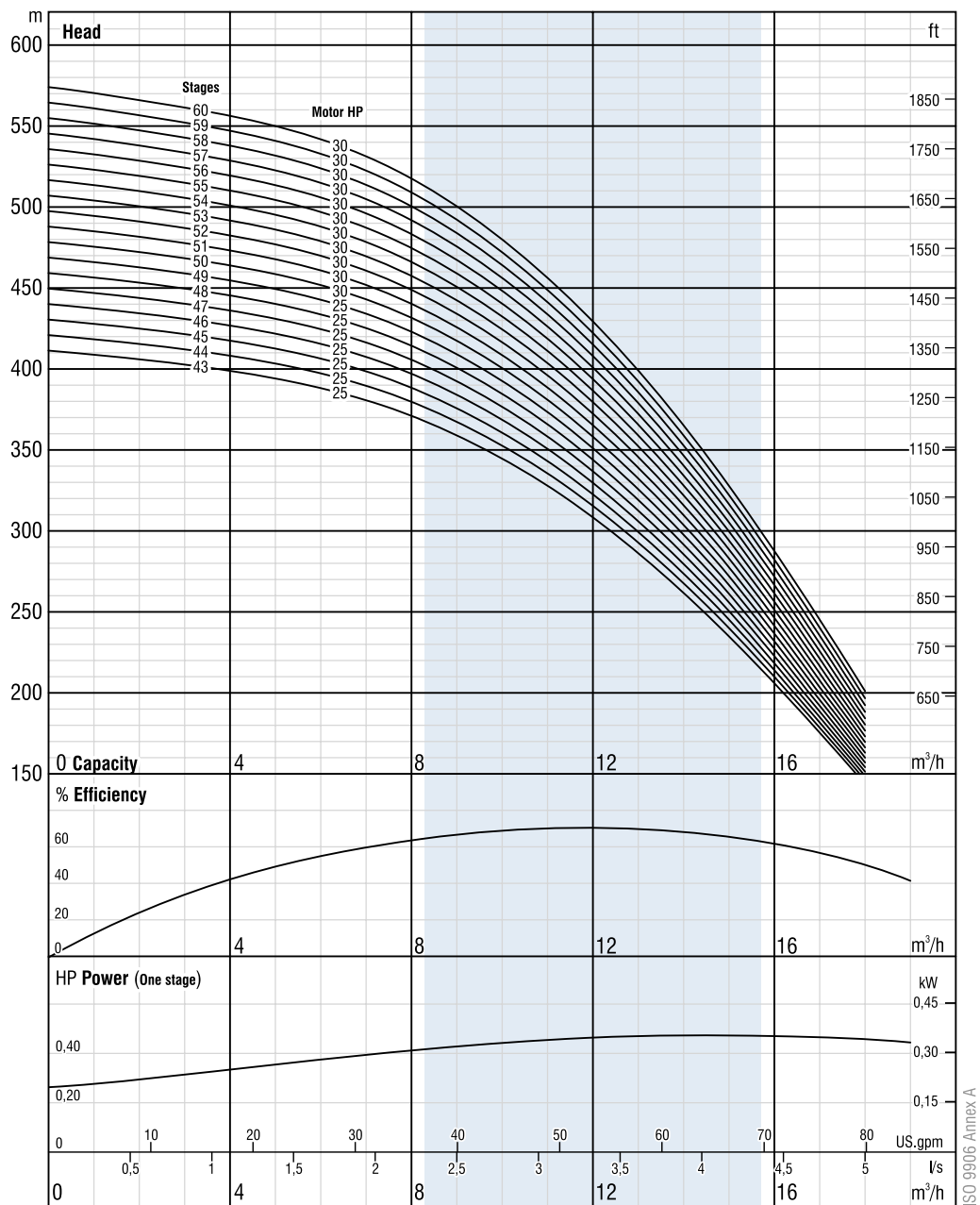

Du fait de l'amélioration continue de la conception, nous nous réservons le droit d'amender les spécifications ou données sans préavis.

ISO 9906 Annex A

# 6" BSP SS 06010 43-53

## Spécifications techniques

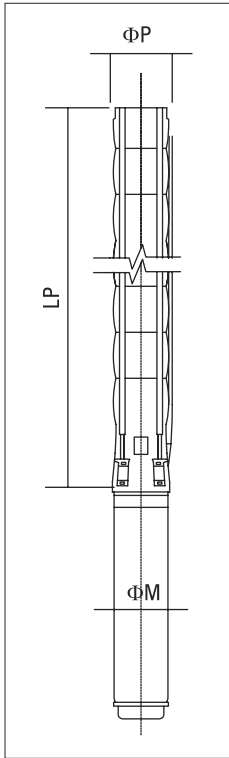

### Dimensions

Modèle	Phases	kW	HP	LP [mm]	ΦM [mm]	ΦP [inch]	Pompe poids [kg]
BSP SS 06010/43 (*)	43	18,5	25	3121	142	6"	98
BSP SS 06010/44 (*)	44	18,5	25	3181	142	6"	100
BSP SS 06010/45 (*)	45	18,5	25	3242	142	6"	101
BSP SS 06010/46 (*)	46	18,5	25	3302	142	6"	103
BSP SS 06010/47 (*)	47	18,5	25	3363	142	6"	105
BSP SS 06010/48 (*)	48	18,5	25	3423	142	6"	107
BSP SS 06010/49 (*)	49	18,5	25	3484	142	6"	108
BSP SS 06010/50 (*)	50	22	30	3544	142	6"	110
BSP SS 06010/51 (*)	51	22	30	3605	142	6"	112
BSP SS 06010/52 (*)	52	22	30	3665	142	6"	114
BSP SS 06010/53 (*)	53	22	30	3726	142	6"	116

\* Version Tandem

### Tableau de performances

Modèle	Phases	kW	HP	Q=Débit								
				m <sup>3</sup> /h	0	3,6	7,2	10,8	12,0	14,4	16	18
				l/s	0	1	2	3	3,3	4	4,4	5
				H=Hauteur [m]								
BSP SS 06010/43 (*)	43	18,5	25		411	401	379	331	308	251	206	144
BSP SS 06010/44 (*)	44	18,5	25		421	410	388	339	315	257	211	147
BSP SS 06010/45 (*)	45	18,5	25		431	419	397	346	322	263	216	150
BSP SS 06010/46 (*)	46	18,5	25		440	429	405	354	329	269	221	154
BSP SS 06010/47 (*)	47	18,5	25		450	438	414	362	336	274	225	157
BSP SS 06010/48 (*)	48	18,5	25		459	447	423	369	344	280	230	160
BSP SS 06010/49 (*)	49	18,5	25		469	457	432	377	351	286	235	164
BSP SS 06010/50 (*)	50	22	30		478	466	441	385	358	292	240	167
BSP SS 06010/51 (*)	51	22	30		488	475	449	392	365	298	245	170
BSP SS 06010/52 (*)	52	22	30		497	485	458	400	372	304	249	174
BSP SS 06010/53 (*)	53	22	30		507	494	467	408	379	309	254	177

\* Version Tandem

# 6" BSP SS 06017 01-25

## Courbes de performances

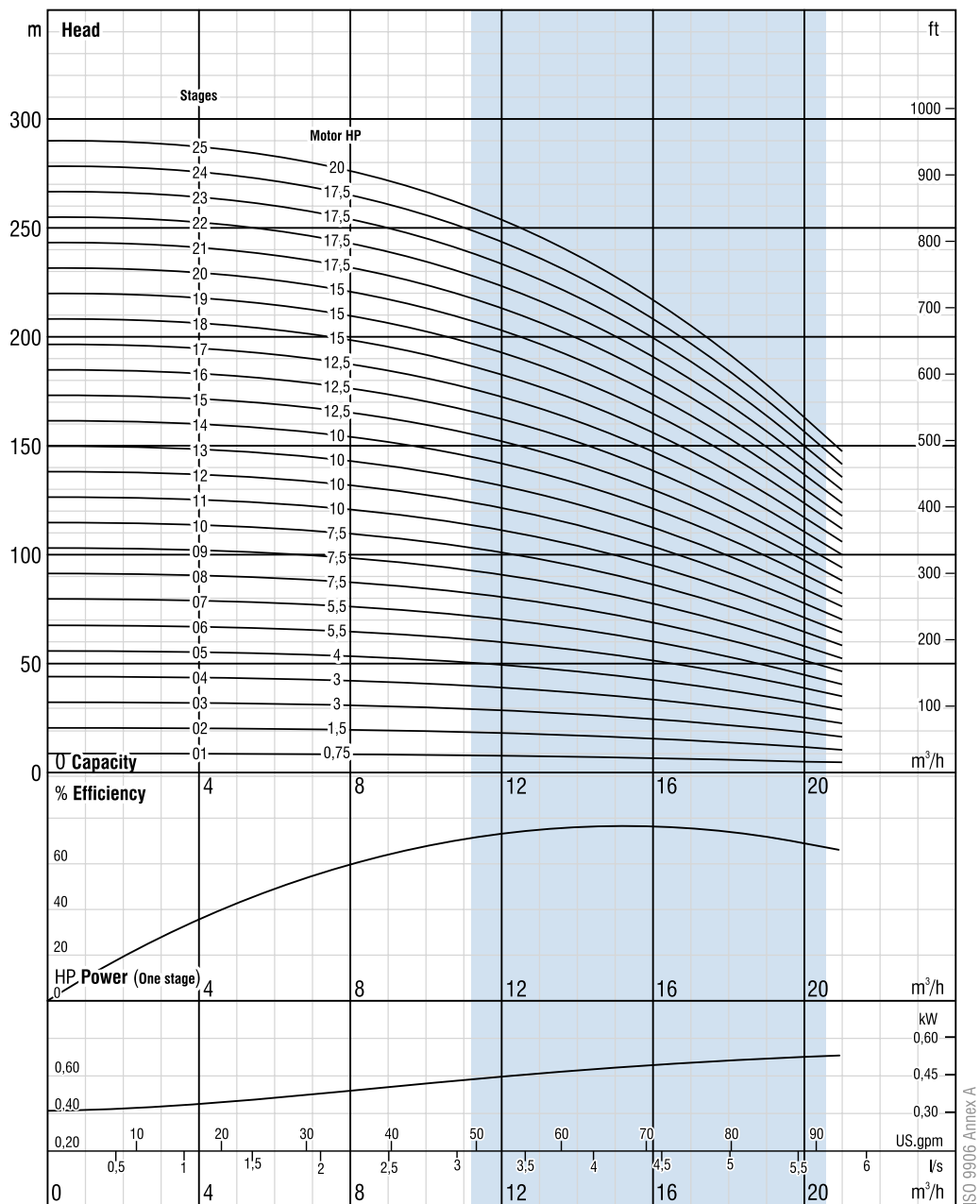

Du fait de l'amélioration continue de la conception, nous nous réservons le droit d'amender les spécifications ou données sans préavis.

ISO 9906 Annex A

# 6" BSP SS 06017 01-25

## Spécifications techniques

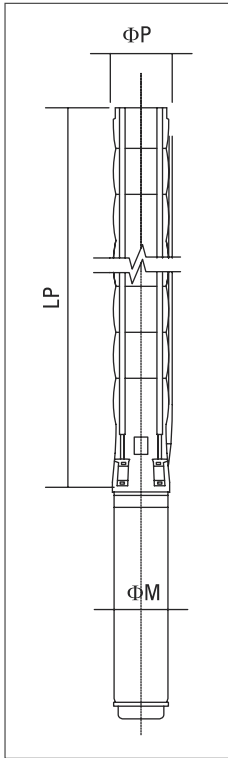

Dimensions							
Modèle	Phases	kW	HP	LP [mm]	ΦM [mm]	ΦP [inch]	Pompe poids [kg]
BSP SS 06017/01	1	0,55	0,75	330	95	6"	5
BSP SS 06017/02	2	1,1	1,5	390	95	6"	7
BSP SS 06017/03	3	2,2	3	451	95	6"	8
BSP SS 06017/04	4	2,2	3	511	95	6"	10
BSP SS 06017/05	5	3	4	572	95	6"	11
BSP SS 06017/06	6	4	5,5	632	(95)/142	6"	13
BSP SS 06017/07	7	4	5,5	693	(95)/142	6"	14
BSP SS 06017/08	8	5,5	7,5	753	(95)/142	6"	16
BSP SS 06017/09	9	5,5	7,5	814	(95)/142	6"	17
BSP SS 06017/10	10	5,5	7,5	874	(95)/142	6"	18
BSP SS 06017/11	11	7,5	10	935	(95)/142	6"	20
BSP SS 06017/12	12	7,5	10	995	(95)/142	6"	21
BSP SS 06017/13	13	7,5	10	1056	(95)/142	6"	23
BSP SS 06017/14	14	7,5	10	1116	(95)/142	6"	24
BSP SS 06017/15	15	9,3	12,5	1177	142	6"	26
BSP SS 06017/16	16	9,3	12,5	1237	142	6"	27
BSP SS 06017/17	17	9,3	12,5	1298	142	6"	29
BSP SS 06017/18	18	11	15	1358	142	6"	30
BSP SS 06017/19	19	11	15	1419	142	6"	31
BSP SS 06017/20	20	11	15	1479	142	6"	33
BSP SS 06017/21	21	13	17,5	1540	142	6"	34
BSP SS 06017/22	22	13	17,5	1600	142	6"	36
BSP SS 06017/23	23	13	17,5	1661	142	6"	37
BSP SS 06017/24	24	13	17,5	1721	142	6"	39
BSP SS 06017/25	25	15	20	1782	142	6"	40

( ) disponible sur demande

## Tableau de performances

Modèle	Phases	kW	HP	Q=Débit									
				m³/h	0	6	8	10	12	14	16	18	20
				l/s	0	1,7	2,2	2,8	3,3	3,9	4,4	5	5,6
				H=Hauteur [m]									
BSP SS 06017/01	1	0,55	0,75	10	10	10	9	9	8	7	7	5	
BSP SS 06017/02	2	1,1	1,5	21	21	20	20	19	17	16	14	12	
BSP SS 06017/03	3	2,2	3	34	33	32	31	30	28	25	22	19	
BSP SS 06017/04	4	2,2	3	46	45	44	42	40	37	34	30	25	
BSP SS 06017/05	5	3	4	57	56	55	53	50	47	43	38	32	
BSP SS 06017/06	6	4	5,5	69	67	66	64	61	56	51	45	39	
BSP SS 06017/07	7	4	5,5	81	79	78	75	72	67	61	54	46	
BSP SS 06017/08	8	5,5	7,5	93	91	89	86	82	76	70	62	53	
BSP SS 06017/09	9	5,5	7,5	104	102	100	97	92	86	78	69	59	
BSP SS 06017/10	10	5,5	7,5	116	113	111	107	102	95	87	77	66	
BSP SS 06017/11	11	7,5	10	127	125	122	118	112	105	96	85	72	
BSP SS 06017/12	12	7,5	10	139	136	133	129	123	115	104	92	79	
BSP SS 06017/13	13	7,5	10	151	148	144	139	133	124	113	100	85	
BSP SS 06017/14	14	7,5	10	162	159	155	150	143	134	122	108	92	
BSP SS 06017/15	15	9,3	12,5	174	170	166	161	153	143	131	115	98	
BSP SS 06017/16	16	9,3	12,5	185	182	178	172	164	153	139	123	105	
BSP SS 06017/17	17	9,3	12,5	197	193	189	182	174	162	148	131	112	
BSP SS 06017/18	18	11	15	209	204	200	193	184	172	157	139	118	
BSP SS 06017/19	19	11	15	220	216	211	204	194	181	165	146	125	
BSP SS 06017/20	20	11	15	232	227	222	215	204	191	174	154	131	
BSP SS 06017/21	21	13	17,5	243	238	233	225	215	200	183	162	138	
BSP SS 06017/22	22	13	17,5	255	250	244	236	225	210	191	169	144	
BSP SS 06017/23	23	13	17,5	266	261	255	247	235	220	200	177	151	
BSP SS 06017/24	24	13	17,5	278	272	266	258	245	229	209	185	158	
BSP SS 06017/25	25	15	20	290	284	277	268	255	239	218	192	164	

# 6" BSP SS 06017 26-43

## Courbes de performances

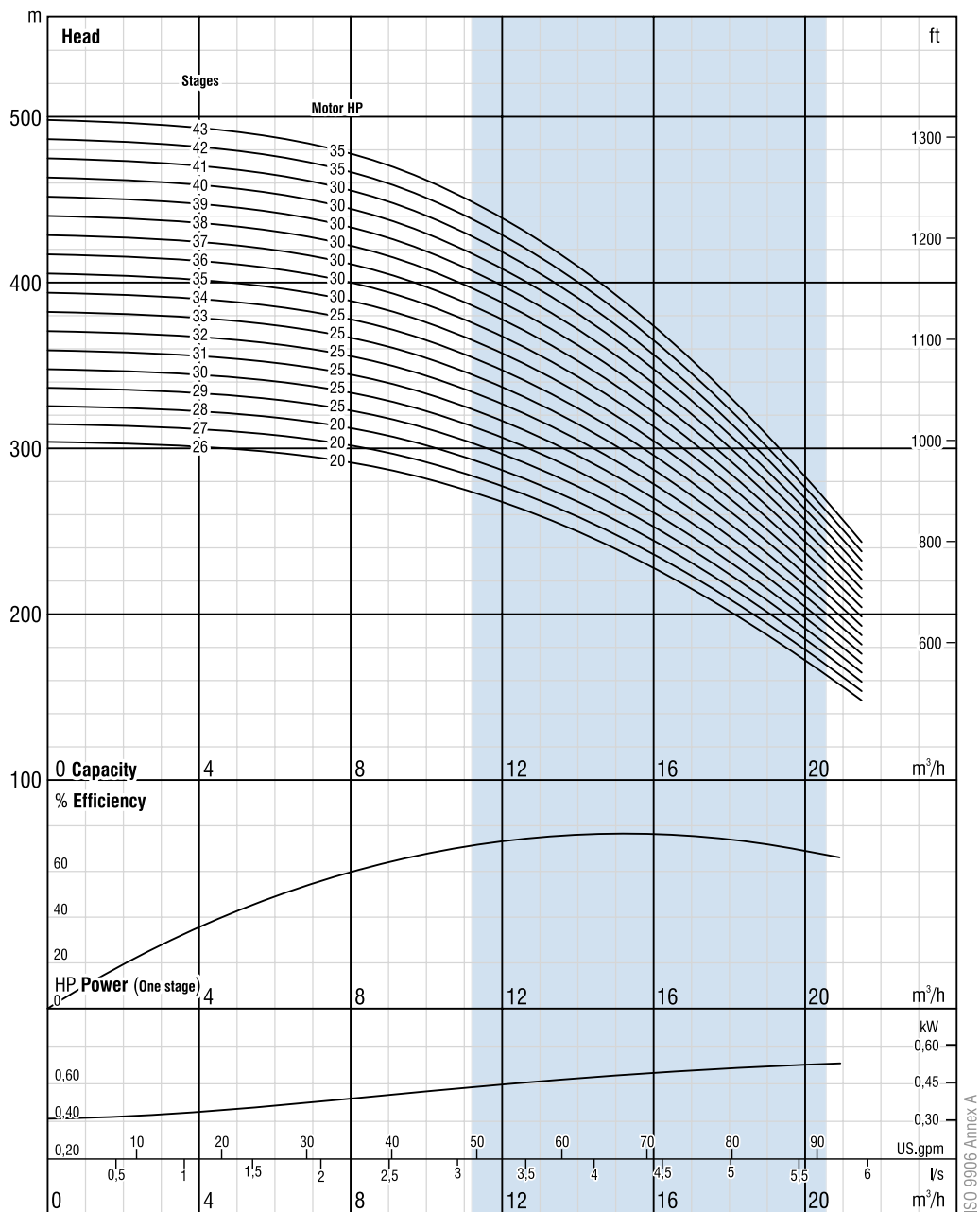

Du fait de l'amélioration continue de la conception, nous nous réservons le droit d'amender les spécifications ou données sans préavis.

ISO 9906 Annex A

# 6" BSP SS 06017 26-43

## Spécifications techniques

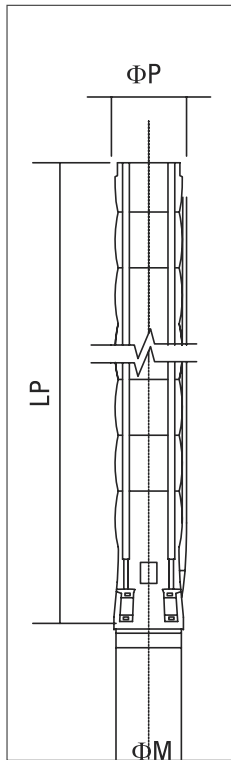

### Dimensions

Modèle	Phases	kW	HP	LP [mm]	ΦM [mm]	ΦP [inch]	Pompe poids [kg]
BSP SS 06017/26	26	15	20	1842	142	6"	42
BSP SS 06017/27	27	15	20	1903	142	6"	43
BSP SS 06017/28	28	15	20	1963	142	6"	45
BSP SS 06017/29	29	18,5	25	2024	142	6"	46
BSP SS 06017/30	30	18,5	25	2084	142	6"	47
BSP SS 06017/31	31	18,5	25	2145	142	6"	49
BSP SS 06017/32	32	18,5	25	2205	142	6"	50
BSP SS 06017/33	33	18,5	25	2266	142	6"	52
BSP SS 06017/34	34	18,5	25	2326	142	6"	53
BSP SS 06017/35	35	22	30	2387	142	6"	55
BSP SS 06017/36	36	22	30	2447	142	6"	56
BSP SS 06017/37	37	22	30	2508	142	6"	58
BSP SS 06017/38	38	22	30	2568	142	6"	59
BSP SS 06017/39*	39	22	30	2879	142	6"	60
BSP SS 06017/40*	40	22	30	2939	142	6"	62
BSP SS 06017/41*	41	22	30	3000	142	6"	63
BSP SS 06017/42*	42	26,5	35	3060	142	6"	65
BSP SS 06017/43*	43	26,5	35	3121	142	6"	98

\* Version Tandem  
( ) disponible sur demande

### Tableau de performances

Modèle	Phases	kW	HP	Q=Débit									
				m³/h	0	6	8	10	12	14	16	18	20
				l/s	0	1,7	2,2	2,8	3,3	3,9	4,4	5	5,6
H=Hauteur [m]													
BSP SS 06017/26	26	15	20		301	295	289	279	266	248	226	200	171
BSP SS 06017/27	27	15	20		313	306	300	290	276	258	235	208	177
BSP SS 06017/28	28	15	20		324	318	311	300	286	267	244	216	184
BSP SS 06017/29	29	18,5	25		336	329	322	311	296	277	252	223	190
BSP SS 06017/30	30	18,5	25		348	340	333	322	307	286	261	231	197
BSP SS 06017/31	31	18,5	25		359	352	344	333	317	296	270	239	203
BSP SS 06017/32	32	18,5	25		371	363	355	343	327	305	279	246	210
BSP SS 06017/33	33	18,5	25		382	375	366	354	337	315	287	254	217
BSP SS 06017/34	34	18,5	25		394	386	377	365	347	325	296	262	223
BSP SS 06017/35	35	22	30		405	397	388	376	358	334	305	269	230
BSP SS 06017/36	36	22	30		417	409	400	386	368	344	313	277	236
BSP SS 06017/37	37	22	30		429	420	411	397	378	353	322	285	243
BSP SS 06017/38	38	22	30		440	431	422	408	388	363	331	293	249
BSP SS 06017/39*	39	22	30		452	443	433	418	399	372	339	300	256
BSP SS 06017/40*	40	22	30		463	454	444	429	409	382	348	308	263
BSP SS 06017/41*	41	22	30		475	465	455	440	419	391	357	316	269
BSP SS 06017/42*	42	26,5	35		487	477	466	451	429	401	366	323	276
BSP SS 06017/43*	43	26,5	35		498	488	477	461	439	410	374	331	282

\* Version Tandem

# 6" BSP SS 06017 44-53

## Courbes de performances

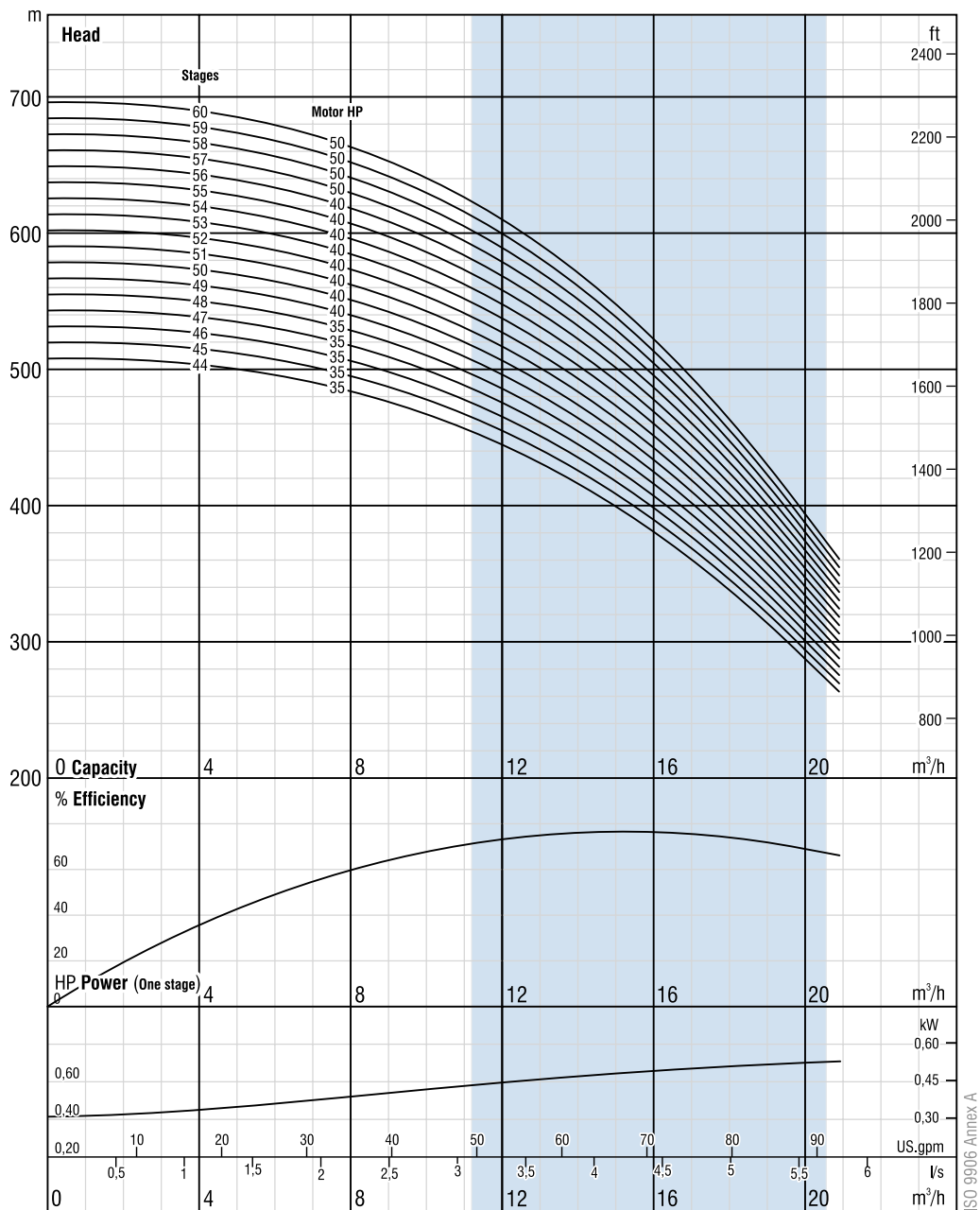

Du fait de l'amélioration continue de la conception, nous nous réservons le droit d'amender les spécifications ou données sans préavis.

ISO 9906 Annex A



# 6" BSP SS 06017 44-53

## Spécifications techniques

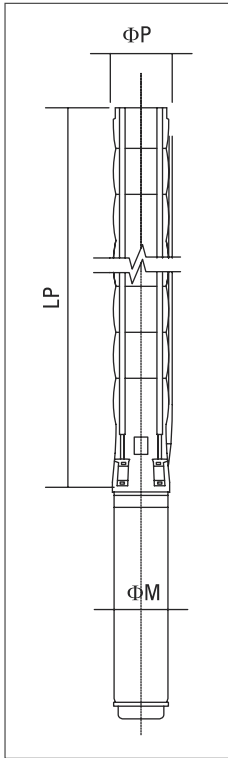

Dimensions							
Modèle	Phases	kW	HP	LP [mm]	ΦM [mm]	ΦP [inch]	Pompe poids [kg]
BSP SS 06017/44 (*)	44	26,5	35	3181	142	6"	100
BSP SS 06017/45 (*)	45	26,5	35	3242	142	6"	102
BSP SS 06017/46 (*)	46	26,5	35	3302	142	6"	103
BSP SS 06017/47 (*)	47	26,5	35	3363	142	6"	105
BSP SS 06017/48 (*)	48	26,5	35	3423	142	6"	107
BSP SS 06017/49 (*)	49	30	40	3484	142/(192)	6"	109
BSP SS 06017/50 (*)	50	30	40	3544	142/(192)	6"	111
BSP SS 06017/51 (*)	51	30	40	3605	142/(192)	6"	112
BSP SS 06017/52 (*)	52	30	40	3665	142/(192)	6"	114
BSP SS 06017/53 (*)	53	30	40	3726	142/(192)	6"	116

\* Version Tandem  
( ) disponible sur demande

### Tableau de performances

Modèle	Phases	kW	HP	Q=Débit									
				m³/h	0	6	8	10	12	14	16	18	20
				l/s	0	1,7	2,2	2,8	3,3	3,9	4,4	5	5,6
H=Hauteur [m]													
BSP SS 06017/44 (*)	44	26,5	35		510	499	488	472	450	420	383	339	289
BSP SS 06017/45 (*)	45	26,5	35		521	511	499	483	460	430	392	346	295
BSP SS 06017/46 (*)	46	26,5	35		533	522	511	494	470	439	400	354	302
BSP SS 06017/47 (*)	47	26,5	35		544	533	522	504	480	449	409	362	308
BSP SS 06017/48 (*)	48	26,5	35		556	545	533	515	491	458	418	370	315
BSP SS 06017/49 (*)	49	30	40		568	556	544	526	501	468	426	377	322
BSP SS 06017/50 (*)	50	30	40		579	567	555	536	511	477	435	385	328
BSP SS 06017/51 (*)	51	30	40		591	579	566	547	521	487	444	393	335
BSP SS 06017/52 (*)	52	30	40		602	590	577	558	531	496	453	400	341
BSP SS 06017/53 (*)	53	30	40		614	602	588	569	542	506	461	408	348

\* Version Tandem

# 6" BSP SS 06030 01-20

## Courbes de performances

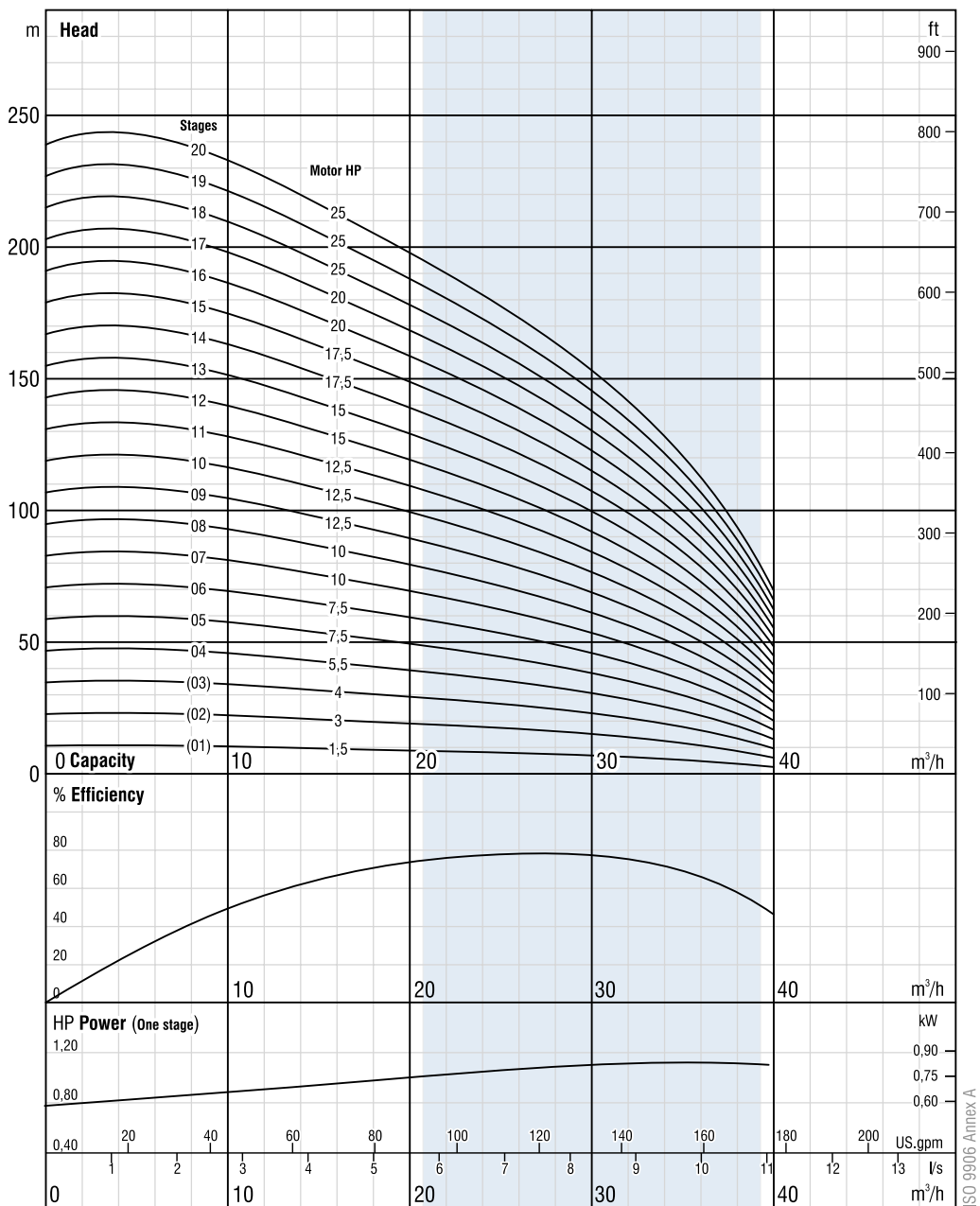

Du fait de l'amélioration continue de la conception, nous nous réservons le droit d'amender les spécifications ou données sans préavis.

ISO 9906 Annex A

# 6" BSP SS 06030 01-20

## Spécifications techniques

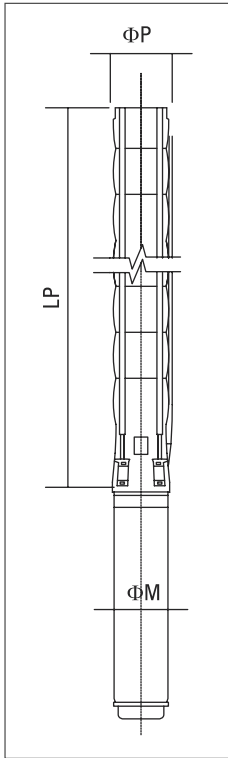

### Dimensions

Modèle	Phases	kW	HP	LP [mm]	ΦM [mm]	ΦP [inch]	Pompe poids [kg]
BSP SS 06030/01	1	1,1	1,5	364	95	6"	6
BSP SS 06030/02	2	2,2	3	459	95	6"	9
BSP SS 06030/03	3	3	4	554	95	6"	11
BSP SS 06030/04	4	4	5,5	649	(95/142)	6"	13
BSP SS 06030/05	5	5,5	7,5	744	(95/142)	6"	15
BSP SS 06030/06	6	5,5	7,5	839	(95/142)	6"	17
BSP SS 06030/07	7	7,5	10	934	(95/142)	6"	19
BSP SS 06030/08	8	7,5	10	1029	(95/142)	6"	21
BSP SS 06030/09	9	9,3	12,5	1124	142	6"	23
BSP SS 06030/10	10	9,3	12,5	1219	142	6"	25
BSP SS 06030/11	11	9,3	12,5	1314	142	6"	27
BSP SS 06030/12	12	11	15	1409	142	6"	29
BSP SS 06030/13	13	11	15	1504	142	6"	31
BSP SS 06030/14	14	13	17,5	1599	142	6"	33
BSP SS 06030/15	15	13	17,5	1694	142	6"	36
BSP SS 06030/16	16	15	20	1789	142	6"	38
BSP SS 06030/17	17	15	20	1884	142	6"	40
BSP SS 06030/18	18	18,5	25	1979	142	6"	42
BSP SS 06030/19	19	18,5	25	2074	142	6"	44
BSP SS 06030/20	20	18,5	25	2169	142	6"	46

( ) disponible sur demande

### Tableau de performances

Modèle	Phases	kW	HP	Q=Débit								
				m³/h	0	7,2	14,4	21,6	24	28,8	36	43,2
				l/s	0	2	4	6	6,6	8	10	12
H=Hauteur [m]												
BSP SS 06030/01	1	1,1	1,5	11	11	10	8	8	7	5	3	
BSP SS 06030/02	2	2,2	3	22	22	20	18	17	15	10	6	
BSP SS 06030/03	3	3	4	33	33	30	26	25	22	15	9	
BSP SS 06030/04	4	4	5,5	48	48	44	38	36	32	22	14	
BSP SS 06030/05	5	5,5	7,5	60	60	55	48	45	40	28	17	
BSP SS 06030/06	6	5,5	7,5	72	72	66	57	54	48	34	21	
BSP SS 06030/07	7	7,5	10	84	84	76	67	64	56	39	24	
BSP SS 06030/08	8	7,5	10	96	96	87	76	73	64	45	28	
BSP SS 06030/09	9	9,3	12,5	107	108	98	86	82	72	51	31	
BSP SS 06030/10	10	9,3	12,5	119	120	109	96	91	80	56	35	
BSP SS 06030/11	11	9,3	12,5	131	132	120	105	100	88	62	38	
BSP SS 06030/12	12	11	15	143	144	131	115	109	96	67	42	
BSP SS 06030/13	13	11	15	155	156	142	124	118	104	73	45	
BSP SS 06030/14	14	13	17,5	167	168	153	134	127	112	79	48	
BSP SS 06030/15	15	13	17,5	179	180	164	143	136	120	84	52	
BSP SS 06030/16	16	15	20	191	192	175	153	145	128	90	55	
BSP SS 06030/17	17	15	20	203	204	186	162	154	136	96	59	
BSP SS 06030/18	18	18,5	25	215	216	197	172	163	144	101	62	
BSP SS 06030/19	19	18,5	25	227	228	207	182	172	152	107	66	
BSP SS 06030/20	20	18,5	25	239	240	218	191	182	160	112	69	

# 6" BSP SS 06030 21-37

## Courbes de performances

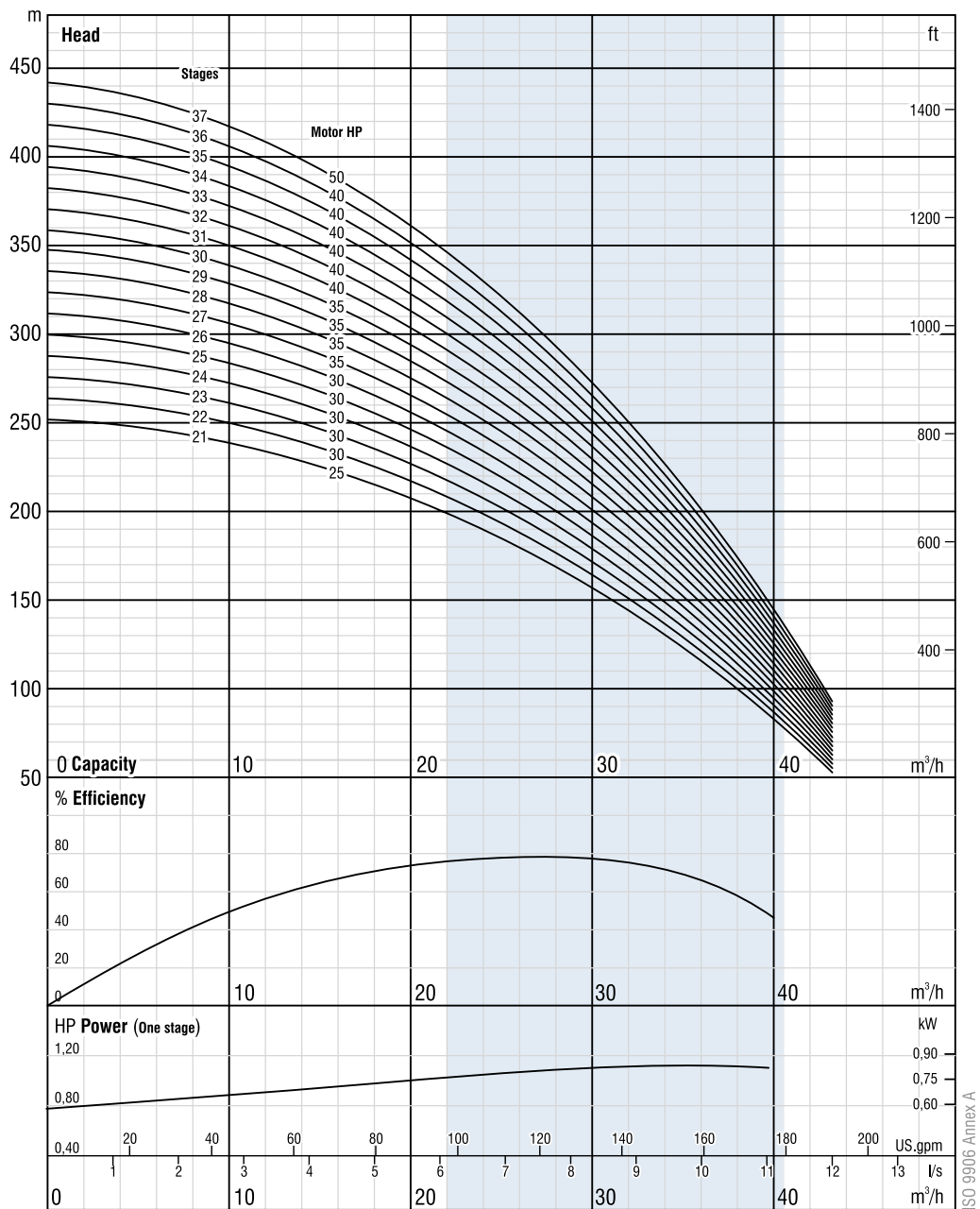

Du fait de l'amélioration continue de la conception, nous nous réservons le droit d'amender les spécifications ou données sans préavis.

# 6" BSP SS 06030 21-37

## Spécifications techniques

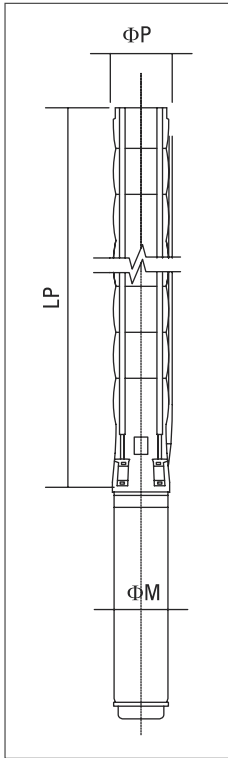

### Dimensions

Modèle	Phases	kW	HP	LP [mm]	ΦM [mm]	ΦP [inch]	Pompe poids [kg]
BSP SS 06030/21	21	18,5	25	2264	142	6"	48
BSP SS 06030/22	22	22	30	2359	142	6"	50
BSP SS 06030/23	23	22	30	2454	142	6"	52
BSP SS 06030/24	24	22	30	2549	142	6"	54
BSP SS 06030/25	25	26,5	35	2644	142	6"	56
BSP SS 06030/26	26	26,5	35	2739	142	6"	58
BSP SS 06030/27	27	26,5	35	2834	142	6"	60
BSP SS 06030/28	28	26,5	35	2929	142	6"	63
BSP SS 06030/29	29	26,5	35	3024	142	6"	65
BSP SS 06030/30	30	26,5	35	3119	142	6"	67
BSP SS 06030/31	31	30	40	3214	142/(192)	6"	69
BSP SS 06030/32	32	30	40	3309	142/(192)	6"	71
BSP SS 06030/33	33	30	40	3404	142/(192)	6"	73
BSP SS 06030/34	34	30	40	3499	142/(192)	6"	75
BSP SS 06030/35	35	30	40	3594	142/(192)	6"	77
BSP SS 06030/36	36	30	40	3689	142/(192)	6"	79
BSP SS 06030/37	37	37	50	3784	142/(192)	6"	81

( ) disponible sur demande

### Tableau de performances

Modèle	Phases	kW	HP									
				m³/h	0	7,2	14,4	21,6	24	28,8	36	43,2
				l/s	0	2	4	6	6,6	8	10	12
BSP SS 06030/21	21	18,5	25		251	252	229	201	191	168	118	73
BSP SS 06030/22	22	22	30		263	264	240	210	200	176	124	76
BSP SS 06030/23	23	22	30		275	276	251	220	209	184	129	80
BSP SS 06030/24	24	22	30		287	288	262	229	218	192	135	83
BSP SS 06030/25	25	26,5	35		299	300	273	239	227	200	141	87
BSP SS 06030/26	26	26,5	35		311	312	284	249	236	208	146	90
BSP SS 06030/27	27	26,5	35		322	324	295	258	245	216	152	93
BSP SS 06030/28	28	26,5	35		334	336	306	268	254	224	157	97
BSP SS 06030/29	29	26,5	35		346	348	317	277	263	232	163	100
BSP SS 06030/30	30	26,5	35		358	360	328	287	272	240	169	104
BSP SS 06030/31	31	30	40		370	372	338	296	281	248	174	107
BSP SS 06030/32	32	30	40		382	384	349	306	291	256	180	111
BSP SS 06030/33	33	30	40		394	396	360	315	300	264	185	114
BSP SS 06030/34	34	30	40		406	408	371	325	309	272	191	118
BSP SS 06030/35	35	30	40		418	420	382	335	318	280	197	121
BSP SS 06030/36	36	30	40		430	432	393	344	327	288	202	125
BSP SS 06030/37	37	37	50		442	444	404	354	336	296	208	128

# 6" BSP SS 06030 38-49

## Courbes de performances

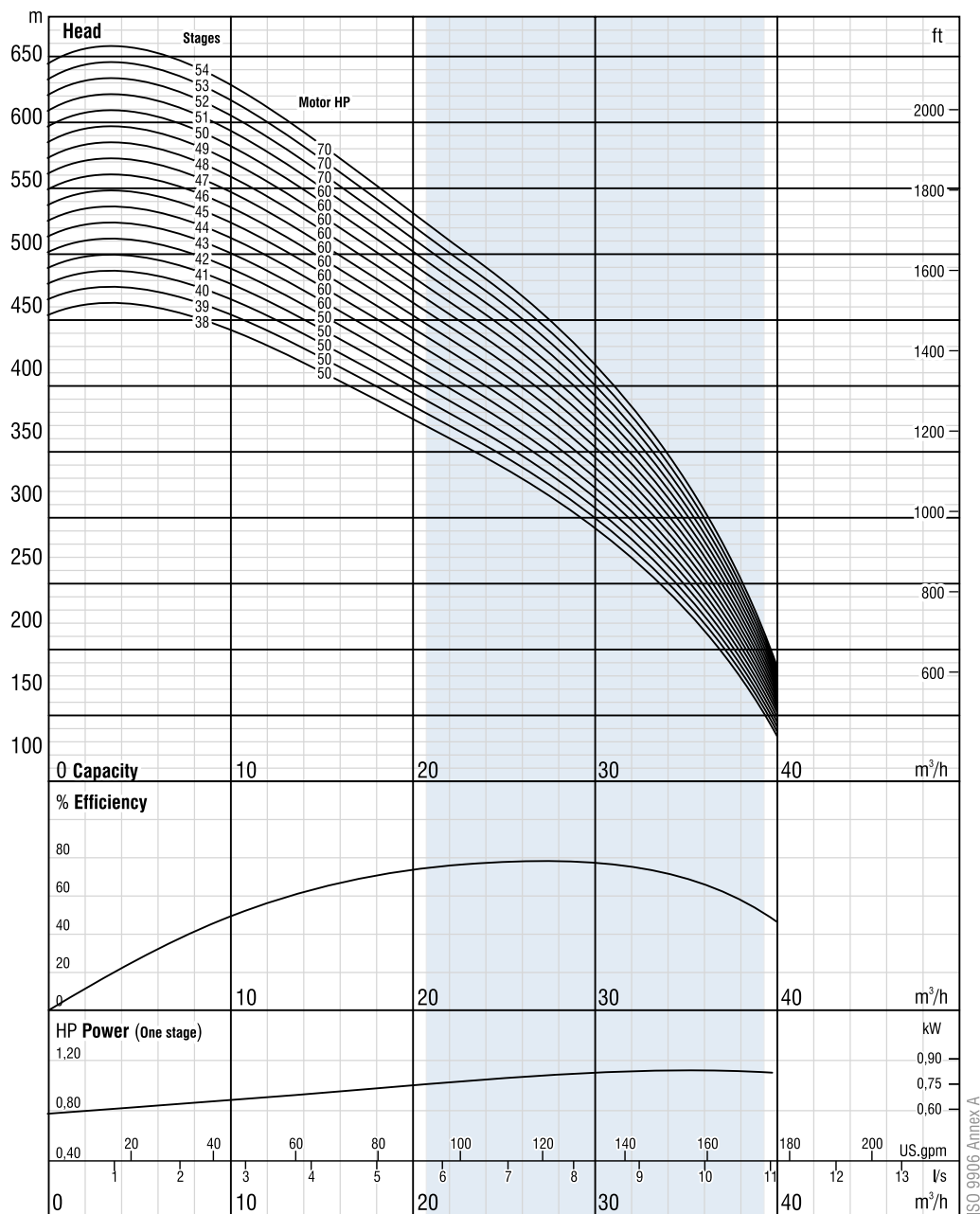

Du fait de l'amélioration continue de la conception, nous nous réservons le droit d'amender les spécifications ou données sans préavis.

# 6" BSP SS 06030 38-49

## Spécifications techniques

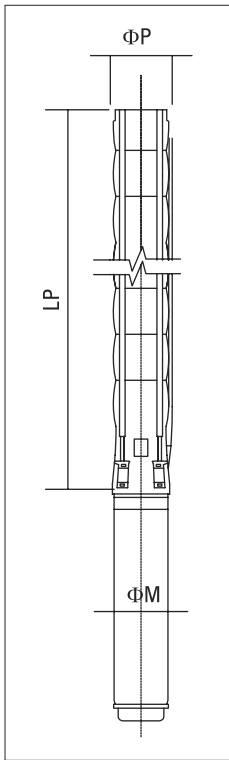

### Dimensions

Modèle	Phases	kW	HP	LP	ΦM	ΦP	Pompe poids [kg]
				[mm]	[mm]	[inch]	
BSP SS 06030/38	38	37	50	3879	142/(192)	132	83
BSP SS 06030/39 (*)	39	37	50	4224	142/(192)	132	124
BSP SS 06030/40 (*)	40	37	50	4319	142/(192)	167	126
BSP SS 06030/41 (*)	41	37	50	4414	142/(192)	167	129
BSP SS 06030/42 (*)	42	37	50	4509	142/(192)	167	132
BSP SS 06030/43 (*)	43	45	60	4604	142/(192)	167	134
BSP SS 06030/44 (*)	44	45	60	4699	142/(192)	167	137
BSP SS 06030/45 (*)	45	45	60	4794	142/(192)	167	139
BSP SS 06030/46 (*)	46	45	60	4889	142/(192)	167	142
BSP SS 06030/47 (*)	47	45	60	4984	142/(192)	167	145
BSP SS 06030/48 (*)	48	45	60	5079	142/(192)	167	147
BSP SS 06030/49 (*)	49	45	60	5174	142/(192)	167	150

\* Version Tandem  
( ) disponible sur demande

### Tableau de performances

Modèle	Phases	kW	HP	Q=Débit								
				m³/h	0	7,2	14,4	21,6	24	28,8	36	43,2
				l/s	0	2	4	6	6,6	8	10	12
H=Hauteur [m]												
BSP SS 06030/38	38	37	50		454	456	415	363	345	304	214	132
BSP SS 06030/39 (*)	39	37	50		466	467	426	373	354	312	219	135
BSP SS 06030/40 (*)	40	37	50		478	479	437	382	363	320	225	138
BSP SS 06030/41 (*)	41	37	50		490	491	448	392	372	328	230	142
BSP SS 06030/42 (*)	42	37	50		502	503	459	401	381	336	236	145
BSP SS 06030/43 (*)	43	45	60		514	515	469	411	390	344	242	149
BSP SS 06030/44 (*)	44	45	60		525	527	480	421	399	352	247	152
BSP SS 06030/45 (*)	45	45	60		537	539	491	430	409	360	253	156
BSP SS 06030/46 (*)	46	45	60		549	551	502	440	418	368	259	159
BSP SS 06030/47 (*)	47	45	60		561	563	513	449	427	376	264	163
BSP SS 06030/48 (*)	48	45	60		573	575	524	459	436	384	270	166
BSP SS 06030/49 (*)	49	45	60		585	587	535	468	445	392	275	170

\* Version Tandem

# 6" BSP SS 06036 01-17

## Courbes de performances

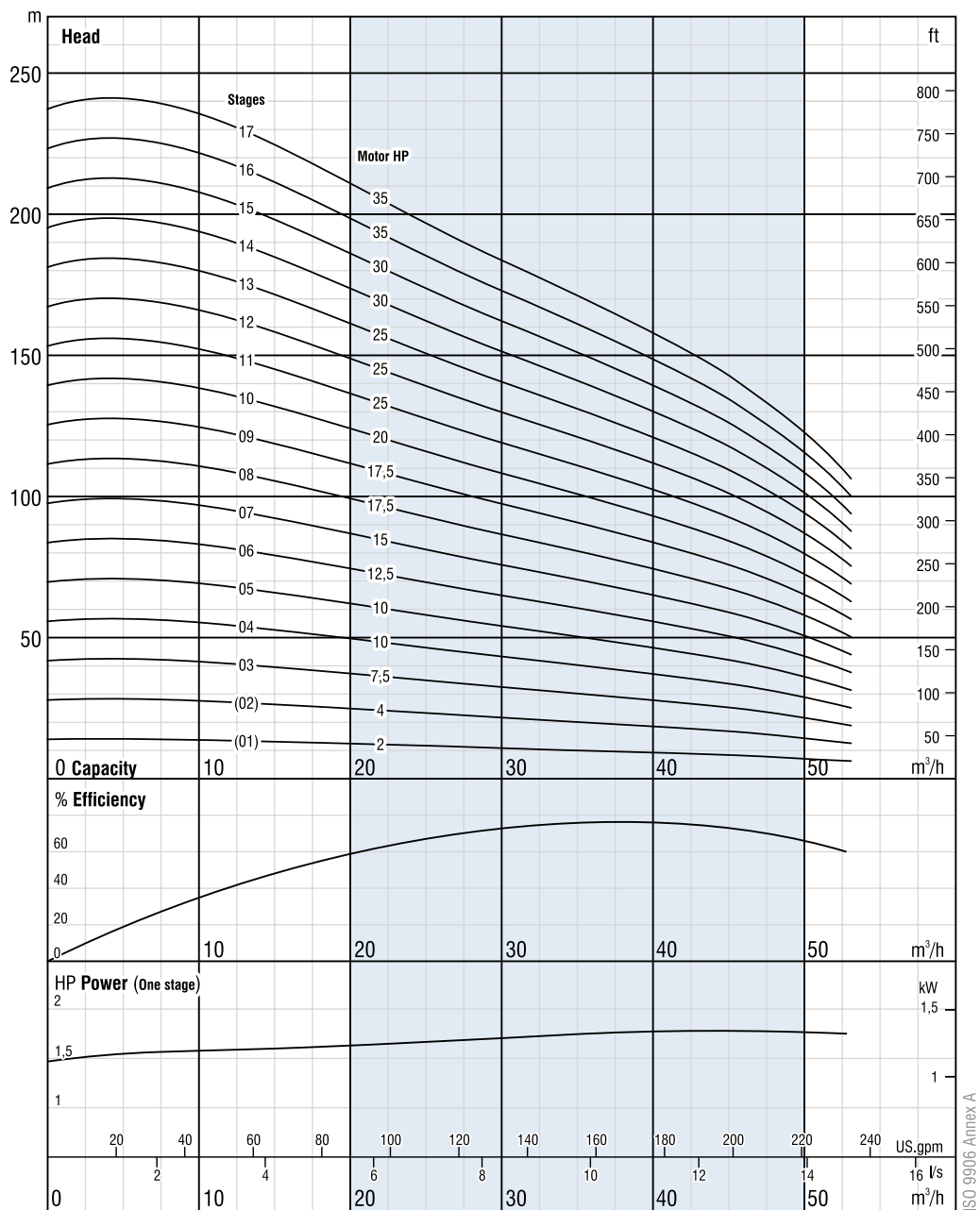

Du fait de l'amélioration continue de la conception, nous nous réservons le droit d'amender les spécifications ou données sans préavis.



# 6" BSP SS 06036 01-17

## Spécifications techniques

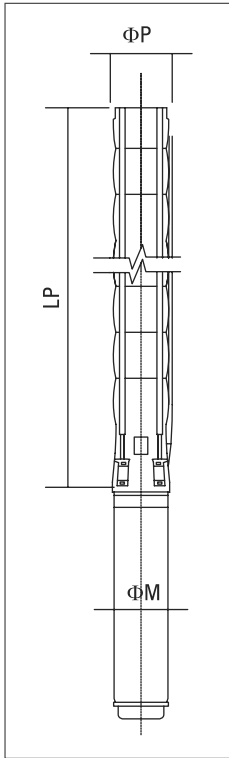

### Dimensions

Modèle	Phases	kW	HP	LP [mm]	ΦM [mm]	ΦP [inch]	Pompe poids [kg]
BSP SS 06036/01	1	1,5	2	382	95	6"	7
BSP SS 06036/02	2	3	4	494	95	6"	10
BSP SS 06036/03	3	5,5	7,5	606	(95)/142	6"	12
BSP SS 06036/04	4	7,5	10	718	(95)/142	6"	15
BSP SS 06036/05	5	7,5	10	830	(95)/142	6"	18
BSP SS 06036/06	6	9,3	12,5	942	142	6"	20
BSP SS 06036/07	7	11	15	1054	142	6"	23
BSP SS 06036/08	8	13	17,5	1166	142	6"	26
BSP SS 06036/09	9	13	17,5	1278	142	6"	28
BSP SS 06036/10	10	15	20	1390	142	6"	31
BSP SS 06036/11	11	18,5	25	1502	142	6"	34
BSP SS 06036/12	12	18,5	25	1614	142	6"	36
BSP SS 06036/13	13	18,5	25	1726	142	6"	39
BSP SS 06036/14	14	22	30	1838	142	6"	42
BSP SS 06036/15	15	22	30	1950	142	6"	44
BSP SS 06036/16	16	26,5	35	2062	142	6"	47
BSP SS 06036/17	17	26,5	35	2174	142	6"	49

( ) disponible sur demande

### Tableau de performances

Modèle	Phases	kW	HP	Q=Débit								
				m³/h	0	8	20	30	35	38	41	50
				l/s	0	2,2	5,6	8,3	9,7	10,6	11,4	13,9
H=Hauteur [m]												
BSP SS 06036/01	1	1,5	2	13	13	11	10	9	8	8	6	
BSP SS 06036/02	2	3	4	27	27	24	21	19	18	18	14	
BSP SS 06036/03	3	5,5	7,5	42	42	37	32	30	29	27	22	
BSP SS 06036/04	4	7,5	10	56	56	50	43	40	38	37	29	
BSP SS 06036/05	5	7,5	10	70	70	62	54	50	48	46	36	
BSP SS 06036/06	6	9,3	12,5	84	84	74	65	60	58	55	44	
BSP SS 06036/07	7	11	15	98	98	87	76	70	67	64	51	
BSP SS 06036/08	8	13	17,5	112	112	99	86	80	77	73	58	
BSP SS 06036/09	9	13	17,5	126	126	112	97	91	87	82	65	
BSP SS 06036/10	10	15	20	140	140	124	108	101	96	91	73	
BSP SS 06036/11	11	18,5	25	154	154	137	119	111	106	101	80	
BSP SS 06036/12	12	18,5	25	167	168	149	130	121	115	110	87	
BSP SS 06036/13	13	18,5	25	181	182	161	140	131	125	119	94	
BSP SS 06036/14	14	22	30	195	196	174	151	141	135	128	102	
BSP SS 06036/15	15	22	30	209	210	186	162	151	144	137	109	
BSP SS 06036/16	16	26,5	35	223	224	199	173	161	154	146	116	
BSP SS 06036/17	17	26,5	35	237	238	211	184	171	163	155	123	

# 6" BSP SS 06036 18-33

## Courbes de performances

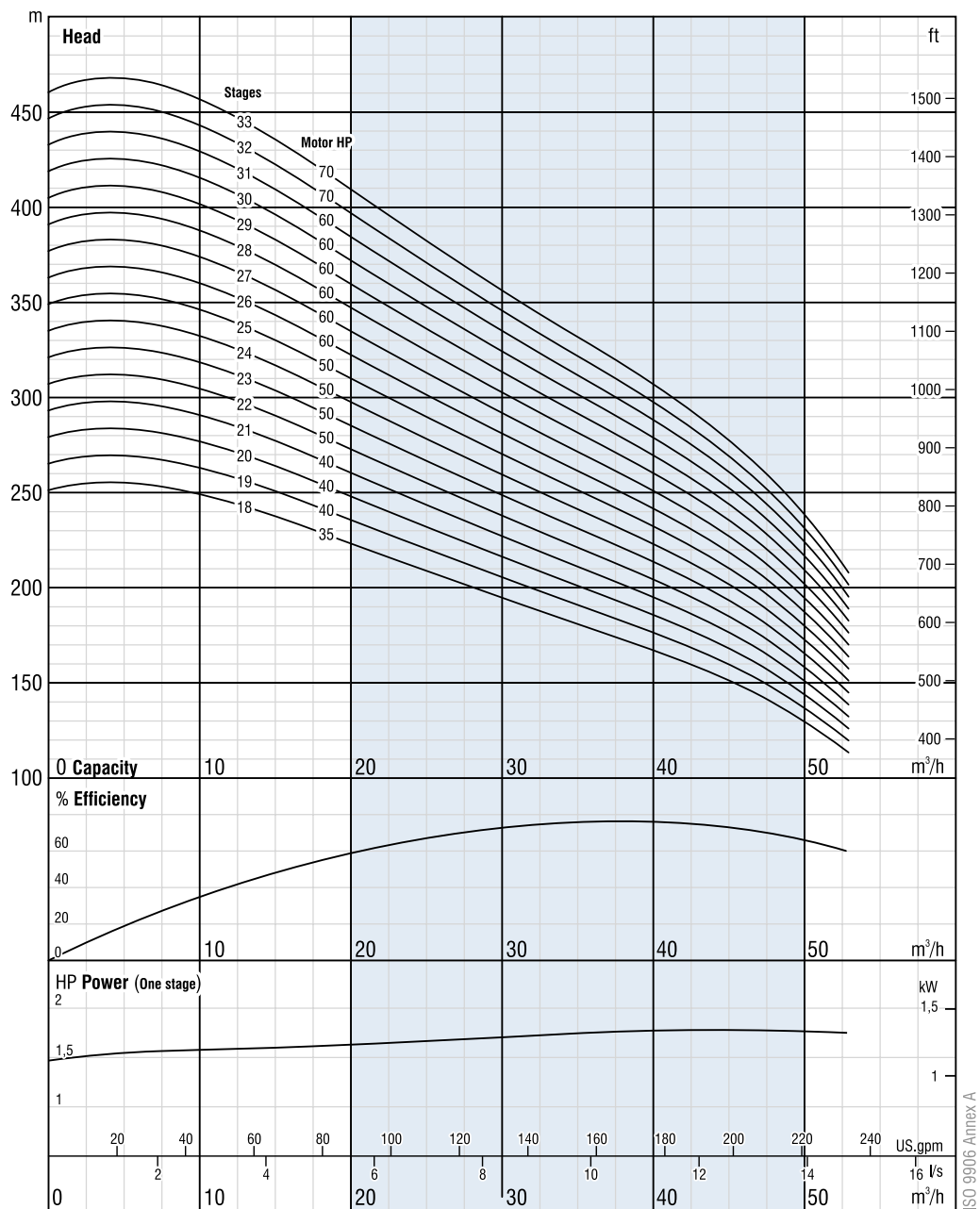

Du fait de l'amélioration continue de la conception, nous nous réservons le droit d'amender les spécifications ou données sans préavis.

ISO 9906 Annex A

# 6" BSP SS 06036 18-33

## Spécifications techniques

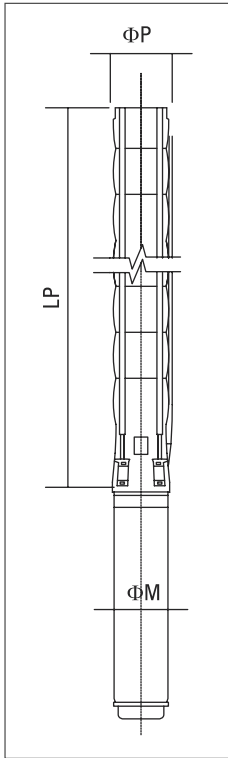

### Dimensions

Modèle	Phases	kW	HP	LP [mm]	ΦM [mm]	ΦP [inch]	Pompe poids [kg]
BSP SS 06036/18	18	26,5	35	2286	142	6"	52
BSP SS 06036/19	19	30	40	2398	142/(192)	6"	55
BSP SS 06036/20	20	30	40	2510	142/(192)	6"	57
BSP SS 06036/21	21	30	40	2622	142/(192)	6"	60
BSP SS 06036/22	22	37	50	2734	142/(192)	6"	63
BSP SS 06036/23	23	37	50	2846	142/(192)	6"	65
BSP SS 06036/24	24	37	50	2958	142/(192)	6"	68
BSP SS 06036/25	25	37	50	3070	142/(192)	6"	71
BSP SS 06036/26	26	45	60	3182	142/(192)	6"	73
BSP SS 06036/27	27	45	60	3294	142/(192)	6"	76
BSP SS 06036/28	28	45	60	3406	142/(192)	6"	79
BSP SS 06036/29	29	45	60	3518	142/(192)	6"	81
BSP SS 06036/30	30	45	60	3630	142/(192)	6"	84
BSP SS 06036/31	31	45	60	3742	142/(192)	6"	86
BSP SS 06036/32	32	52	70	3854	192	6"	89
BSP SS 06036/33	33	52	70	3966	192	6"	92

( ) disponible sur demande

### Tableau de performances

Modèle	Phases	kW	HP	Q=Débit								
				m³/h	0	8	20	30	35	38	41	50
				l/s	0	2,2	5,6	8,3	9,7	10,6	11,4	13,9
H=Hauteur [m]												
BSP SS 06036/18	18	26,5	35	251	252	223	194	181	173	165	131	
BSP SS 06036/19	19	30	40	265	266	236	205	191	183	174	138	
BSP SS 06036/20	20	30	40	279	280	248	216	201	192	183	145	
BSP SS 06036/21	21	30	40	293	294	261	227	211	202	192	152	
BSP SS 06036/22	22	37	50	307	308	273	238	221	211	201	160	
BSP SS 06036/23	23	37	50	321	322	285	248	231	221	210	167	
BSP SS 06036/24	24	37	50	335	337	298	259	241	231	219	174	
BSP SS 06036/25	25	37	50	349	351	310	270	251	240	229	181	
BSP SS 06036/26	26	45	60	363	365	323	281	262	250	238	189	
BSP SS 06036/27	27	45	60	377	379	335	292	272	260	247	196	
BSP SS 06036/28	28	45	60	391	393	347	303	282	269	256	203	
BSP SS 06036/29	29	45	60	405	407	360	313	292	279	265	210	
BSP SS 06036/30	30	45	60	419	421	372	324	302	288	274	218	
BSP SS 06036/31	31	45	60	433	435	385	335	312	298	283	225	
BSP SS 06036/32	32	52	70	447	449	397	346	322	308	293	232	
BSP SS 06036/33	33	52	70	461	463	410	357	332	317	302	239	

# 6" BSP SS 06045 01-19

## Courbes de performances

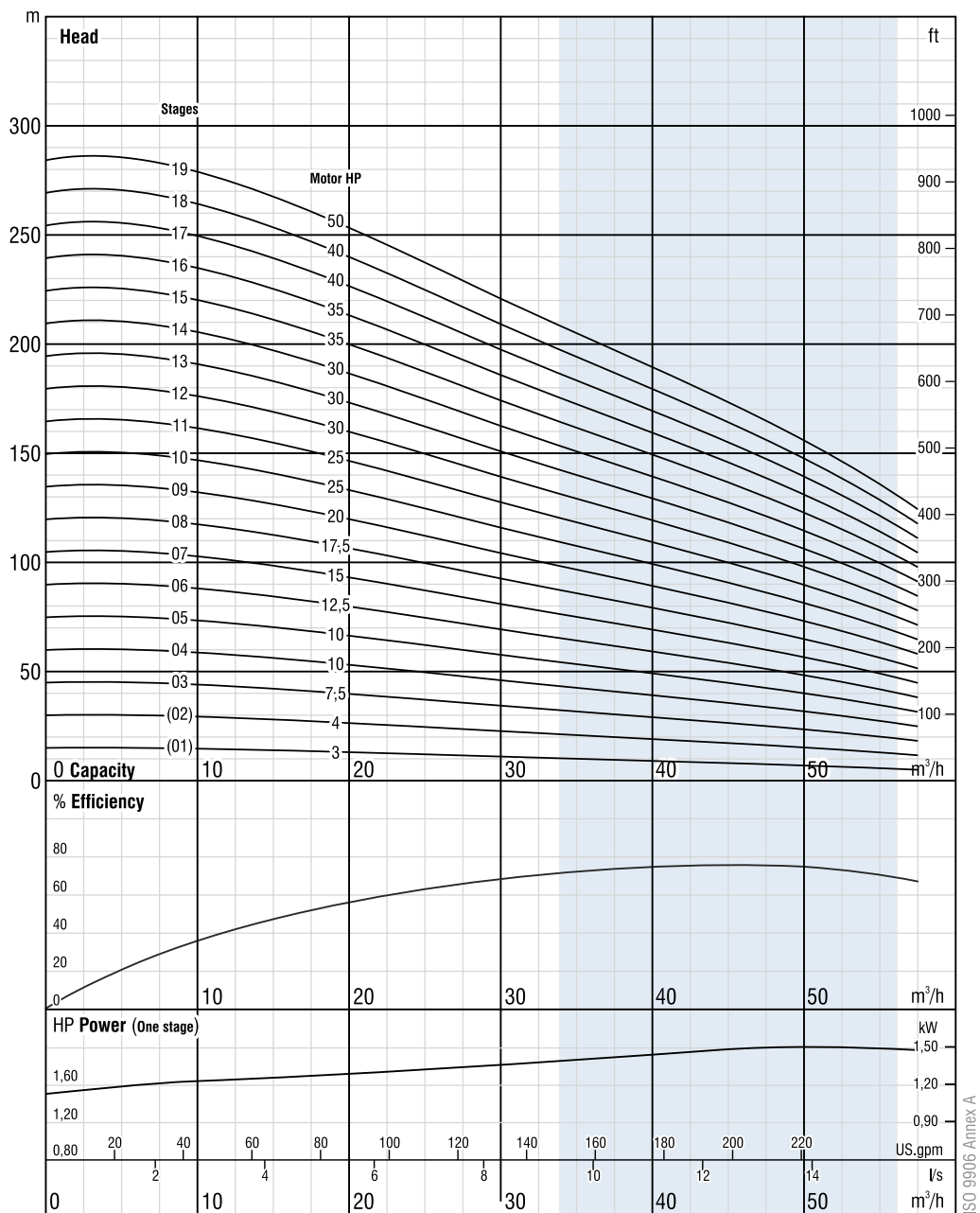

Du fait de l'amélioration continue de la conception, nous nous réservons le droit d'amender les spécifications ou données sans préavis.

# 6" BSP SS 06045 01-17

## Spécifications techniques

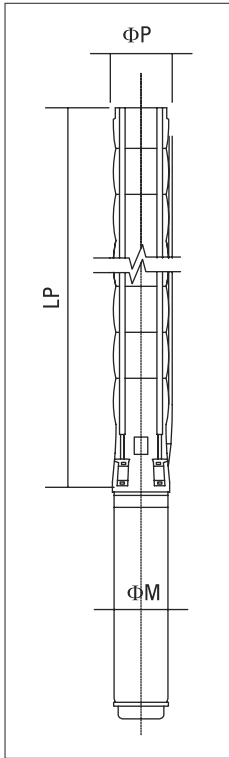

### Dimensions

Modèle	Phases	kW	HP	LP [mm]	ΦM [mm]	ΦP [inch]	Pompe poids [kg]
BSP SS 06045/01	1	2,2	3	382	95	6"	7
BSP SS 06045/02	2	3	4	494	95	6"	10
BSP SS 06045/03	3	5,5	7,5	606	(95)/142	6"	12
BSP SS 06045/04	4	7,5	10	718	(95)/142	6"	15
BSP SS 06045/05	5	7,5	10	830	(95)/142	6"	18
BSP SS 06045/06	6	9,3	12,5	942	142	6"	20
BSP SS 06045/07	7	11	15	1054	142	6"	23
BSP SS 06045/08	8	13	17,5	1166	142	6"	26
BSP SS 06045/09	9	15	20	1278	142	6"	28
BSP SS 06045/10	10	18,5	25	1390	142	6"	31
BSP SS 06045/11	11	18,5	25	1502	142	6"	34
BSP SS 06045/12	12	22	30	1614	142	6"	36
BSP SS 06045/13	13	22	30	1726	142	6"	39
BSP SS 06045/14	14	22	30	1838	142	6"	42
BSP SS 06045/15	15	26,5	35	1950	142	6"	44
BSP SS 06045/16	16	26,5	35	2062	142	6"	47
BSP SS 06045/17	17	30	40	2174	142/(192)	6"	49
BSP SS 06045/18	18	30	40	2286	142/(192)	6"	52
BSP SS 06045/19	19	37	50	2398	142/(192)	6"	55

( ) disponible sur demande

### Tableau de performances

Modèle	Phases	kW	HP	Q=Débit								
				m³/h	0	21,6	28,8	36	43,2	46,8	50,4	58
				l/s	0	6	8	10	12	13	14	16,1
H=Hauteur [m]												
BSP SS 06045/01	1	2,2	3	15	12	11	9	8	7	7	5	
BSP SS 06045/02	2	3	4	29	25	22	19	17	16	14	11	
BSP SS 06045/03	3	5,5	7,5	45	39	35	32	28	26	24	20	
BSP SS 06045/04	4	7,5	10	60	52	47	42	38	35	32	26	
BSP SS 06045/05	5	7,5	10	74	65	59	53	47	44	41	33	
BSP SS 06045/06	6	9,3	12,5	89	78	71	64	56	53	49	39	
BSP SS 06045/07	7	11	15	104	91	83	74	66	61	57	46	
BSP SS 06045/08	8	13	17,5	119	104	95	85	75	70	65	52	
BSP SS 06045/09	9	15	20	134	117	106	95	85	79	73	59	
BSP SS 06045/10	10	18,5	25	149	130	118	106	94	88	81	65	
BSP SS 06045/11	11	18,5	25	164	144	130	117	103	96	89	72	
BSP SS 06045/12	12	22	30	179	157	142	127	113	105	97	78	
BSP SS 06045/13	13	22	30	193	170	154	138	122	114	106	85	
BSP SS 06045/14	14	22	30	208	183	166	148	131	123	114	91	
BSP SS 06045/15	15	26,5	35	223	196	177	159	141	132	122	98	
BSP SS 06045/16	16	26,5	35	238	209	189	170	150	140	130	104	
BSP SS 06045/17	17	30	40	253	222	201	180	160	149	138	111	
BSP SS 06045/18	18	30	40	268	235	213	191	169	158	146	117	
BSP SS 06045/19	19	37	50	283	248	225	201	178	167	154	124	

# 6" BSP SS 06045 20-33

## Courbes de performances

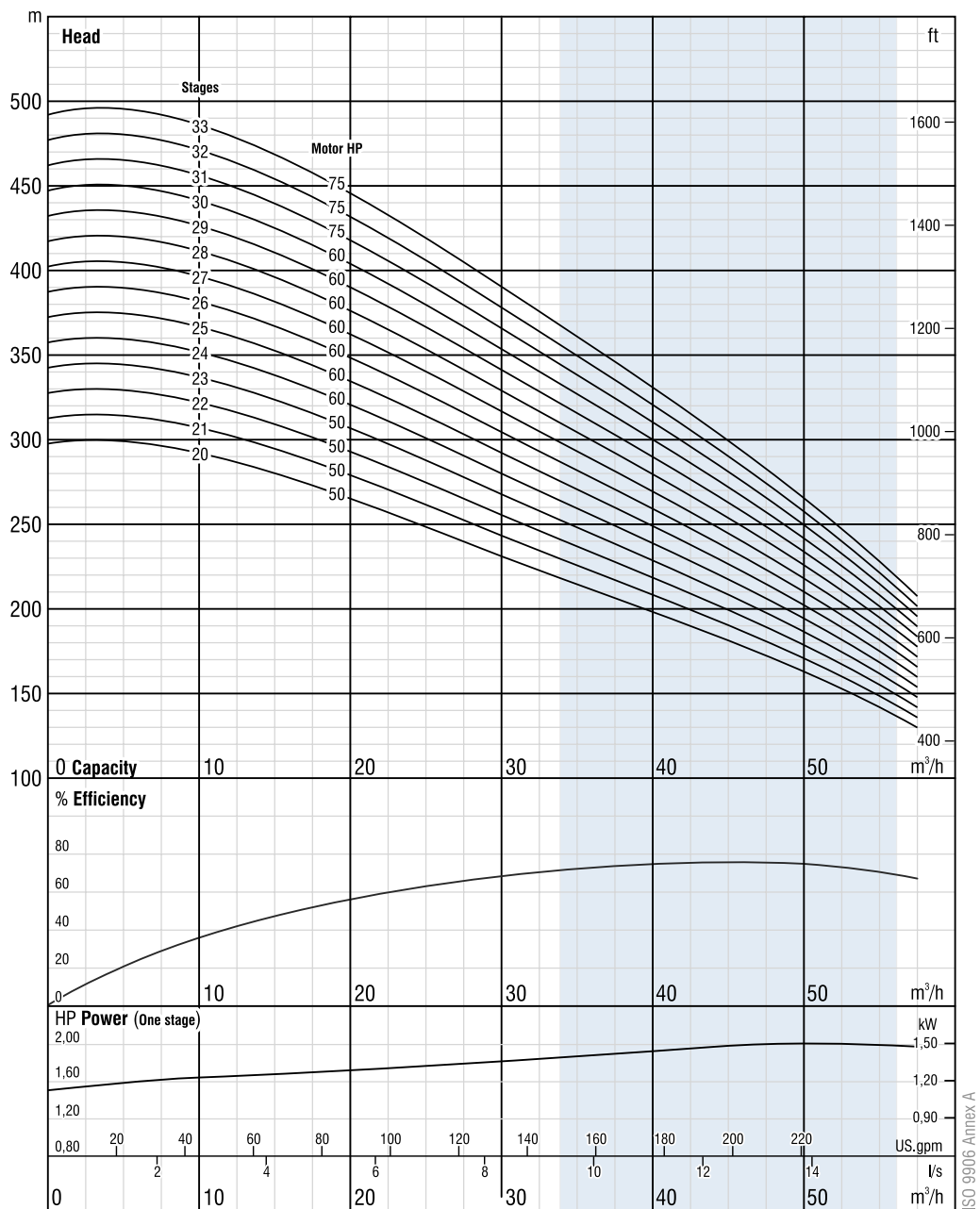

Du fait de l'amélioration continue de la conception, nous nous réservons le droit d'amender les spécifications ou données sans préavis.

ISO 9906 Annex A

# 6" BSP SS 06045 20-33

## Spécifications techniques

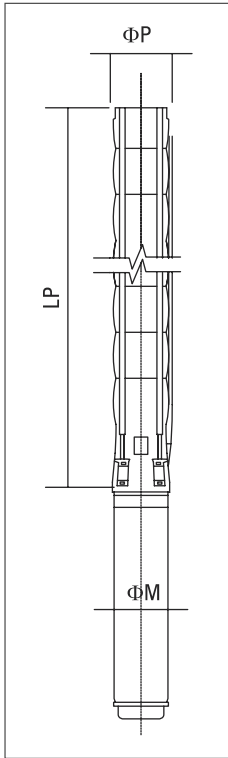

### Dimensions

Modèle	Phases	kW	HP	LP [mm]	ΦM [mm]	ΦP [inch]	Pompe poids [kg]
BSP SS 06045/20	20	37	50	2510	142/(192)	6"	57
BSP SS 06045/21	21	37	50	2622	142/(192)	6"	60
BSP SS 06045/22	22	37	50	2734	142/(192)	6"	63
BSP SS 06045/23	23	37	50	2846	142/(192)	6"	65
BSP SS 06045/24	24	45	60	2958	142/(192)	6"	68
BSP SS 06045/25	25	45	60	3070	142/(192)	6"	71
BSP SS 06045/26	26	45	60	3182	142/(192)	6"	73
BSP SS 06045/27	27	45	60	3294	142/(192)	6"	76
BSP SS 06045/28	28	45	60	3406	142/(192)	6"	79
BSP SS 06045/29	29	45	60	3518	142/(192)	6"	81
BSP SS 06045/30	30	45	60	3630	142/(192)	6"	84
BSP SS 06045/31	31	55	75	3742	192	6"	86
BSP SS 06045/32	32	55	75	3854	192	6"	89
BSP SS 06045/33	33	55	75	3966	192	6"	92

( ) disponible sur demande

### Tableau de performances

Modèle	Phases	kW	HP	Q=Débit								
				m³/h	0	21,6	28,8	36	43,2	46,8	50,4	58
				l/s	0	6	8	10	12	13	14	16,1
H=Hauteur [m]												
BSP SS 06045/20	20	37	50		298	261	237	212	188	175	162	130
BSP SS 06045/21	21	37	50		313	274	248	223	197	184	171	137
BSP SS 06045/22	22	37	50		327	287	260	233	207	193	179	144
BSP SS 06045/23	23	37	50		342	300	272	244	216	202	187	150
BSP SS 06045/24	24	45	60		357	313	284	254	225	211	195	157
BSP SS 06045/25	25	45	60		372	326	296	265	235	219	203	163
BSP SS 06045/26	26	45	60		387	339	307	276	244	228	211	170
BSP SS 06045/27	27	45	60		402	352	319	286	254	237	219	176
BSP SS 06045/28	28	45	60		417	365	331	297	263	246	227	183
BSP SS 06045/29	29	45	60		432	378	343	307	272	254	236	189
BSP SS 06045/30	30	45	60		447	391	355	318	282	263	244	196
BSP SS 06045/31	31	55	75		461	404	367	329	291	272	252	202
BSP SS 06045/32	32	55	75		476	417	378	339	300	281	260	209
BSP SS 06045/33	33	55	75		491	431	390	350	310	289	268	215

# 6" BSP SS 06060 01-17

## Courbes de performances

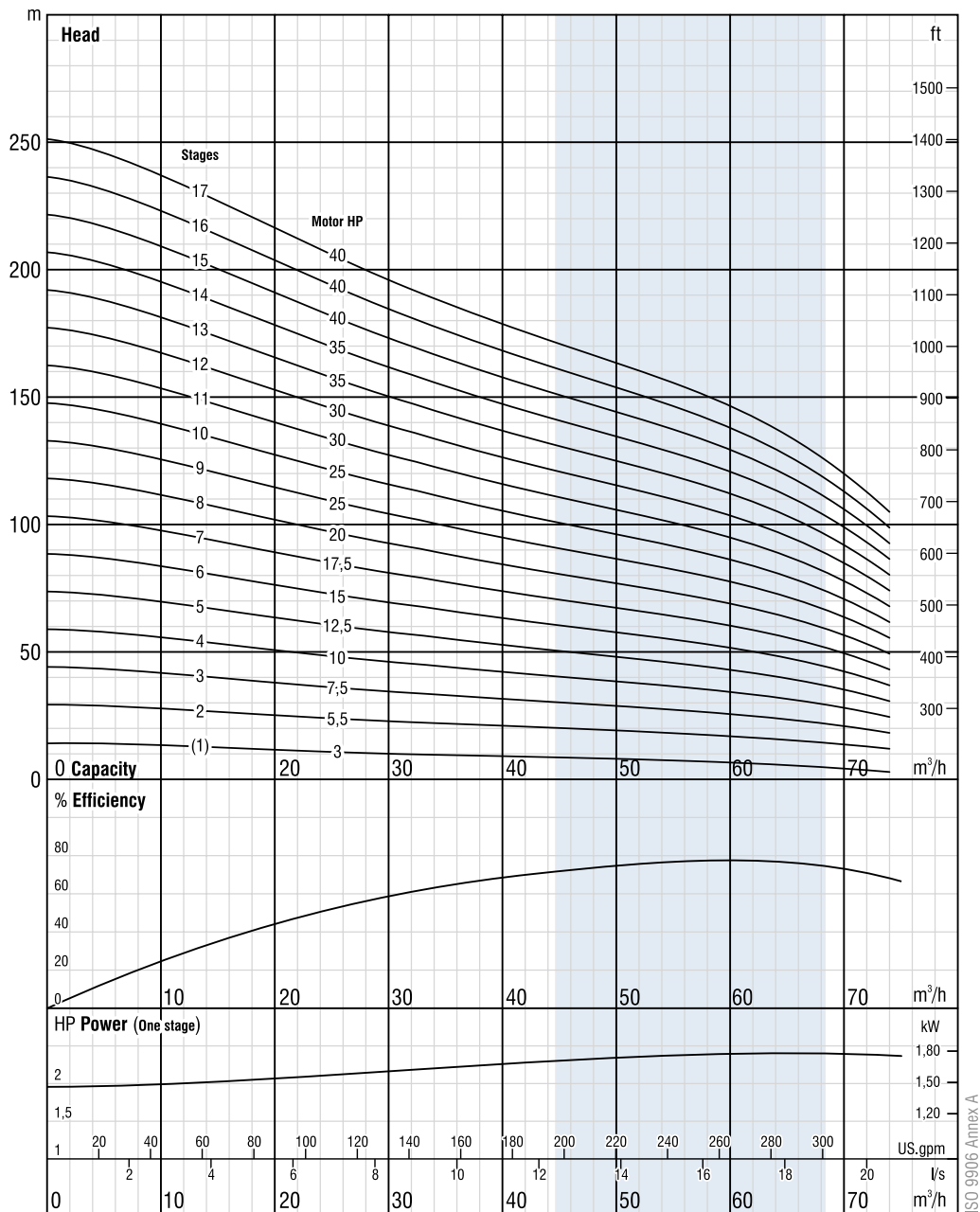

Du fait de l'amélioration continue de la conception, nous nous réservons le droit d'amender les spécifications ou données sans préavis.



# 6" BSP SS 06060 01-17

## Spécifications techniques

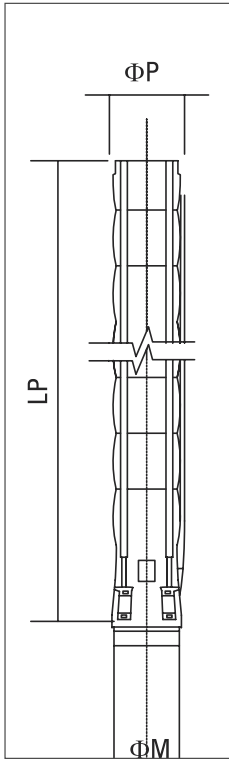

### Dimensions

Modèle	Phases	kW	HP	LP [mm]	ΦM [mm]	ΦP [inch]	Pompe poids [kg]
BSP SS 06060/01	1	2,2	3	382	95	6"	7
BSP SS 06060/02	2	4	5,5	494	(95)/142	6"	10
BSP SS 06060/03	3	5,5	7,5	606	(95)/142	6"	12
BSP SS 06060/04	4	7,5	10	718	(95)/142	6"	15
BSP SS 06060/05	5	9,3	12,5	830	142	6"	18
BSP SS 06060/06	6	11	15	942	142	6"	20
BSP SS 06060/07	7	13	17,5	1054	142	6"	23
BSP SS 06060/08	8	15	20	1166	142	6"	26
BSP SS 06060/09	9	18,5	25	1278	142	6"	28
BSP SS 06060/10	10	18,5	25	1390	142	6"	31
BSP SS 06060/11	11	22	30	1502	142	6"	34
BSP SS 06060/12	12	22	30	1614	142	6"	36
BSP SS 06060/13	13	26,5	35	1726	142	6"	39
BSP SS 06060/14	14	26,5	35	1838	142	6"	42
BSP SS 06060/15	15	30	40	1950	142/(192)	6"	44
BSP SS 06060/16	16	30	40	2062	142/(192)	6"	47
BSP SS 06060/17	17	30	40	2174	142/(192)	6"	50

( ) disponible sur demande

### Tableau de performances

Modèle	Phases	kW	HP	Q=Débit								
				m³/h	0	30	36	43	51	58	65	72
				l/s	0	8,3	10	11,9	14,2	16,1	18,1	20
H=Hauteur [m]												
BSP SS 06060/01	1	2,2	3	14	10	9	8	7	6	5	3	
BSP SS 06060/02	2	4	5,5	30	23	22	20	19	17	15	12	
BSP SS 06060/03	3	5,5	7,5	44	35	33	31	28	26	23	18	
BSP SS 06060/04	4	7,5	10	59	47	44	41	38	35	31	25	
BSP SS 06060/05	5	9,3	12,5	74	59	55	51	47	43	38	31	
BSP SS 06060/06	6	11	15	89	70	66	61	56	52	46	37	
BSP SS 06060/07	7	13	17,5	104	82	77	72	66	60	53	43	
BSP SS 06060/08	8	15	20	118	94	88	82	75	69	61	49	
BSP SS 06060/09	9	18,5	25	133	105	99	92	85	78	69	55	
BSP SS 06060/10	10	18,5	25	148	117	110	102	94	86	76	62	
BSP SS 06060/11	11	22	30	163	129	121	112	104	95	84	68	
BSP SS 06060/12	12	22	30	178	140	132	123	113	104	92	74	
BSP SS 06060/13	13	26,5	35	192	152	143	133	122	112	99	80	
BSP SS 06060/14	14	26,5	35	207	164	154	143	132	121	107	86	
BSP SS 06060/15	15	30	40	222	176	165	153	141	130	114	92	
BSP SS 06060/16	16	30	40	237	187	176	164	151	138	122	99	
BSP SS 06060/17	17	30	40	252	199	187	174	160	147	130	105	

# 6" BSP SS 06060 18-30

## Courbes de performances

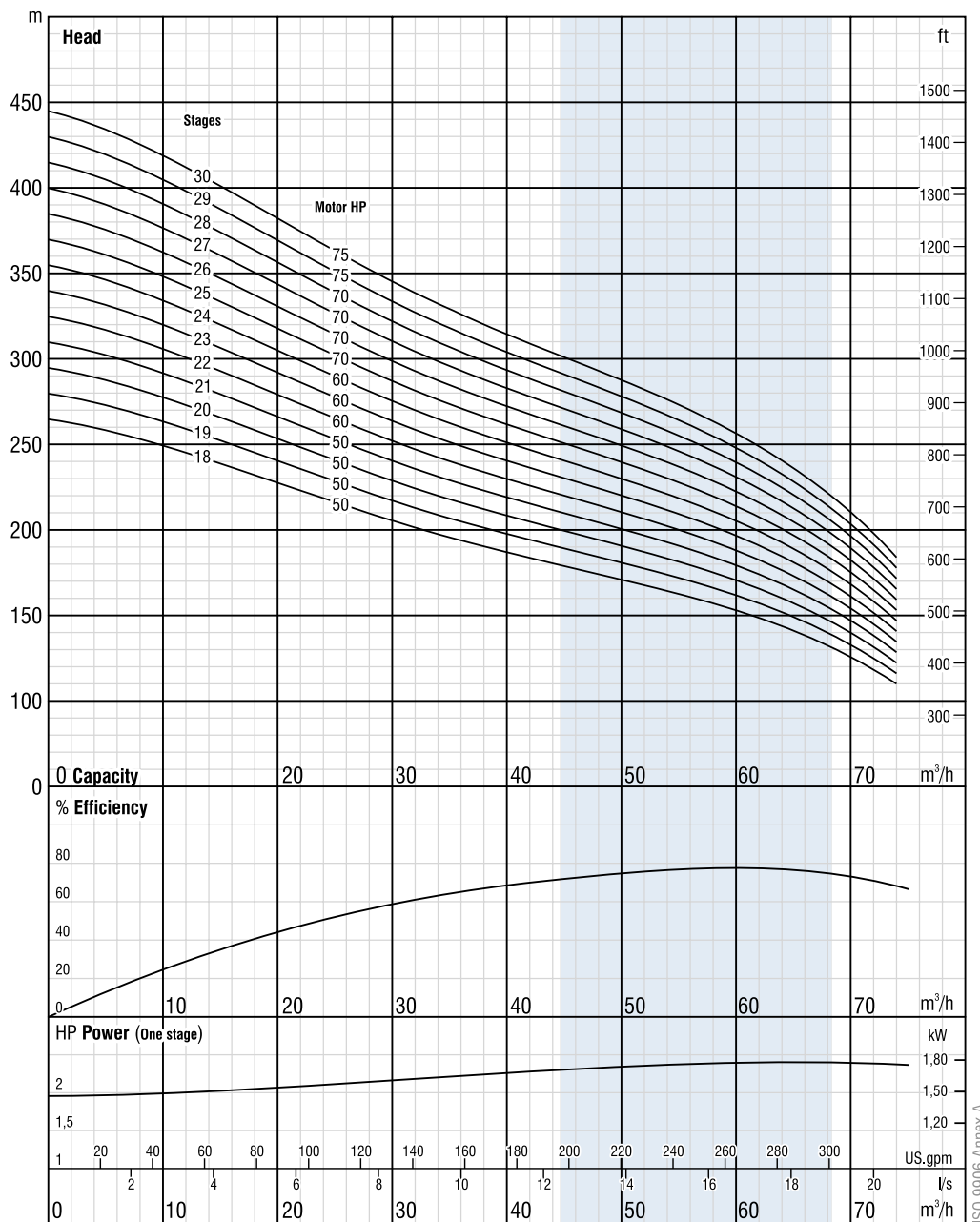

Du fait de l'amélioration continue de la conception, nous nous réservons le droit d'amender les spécifications ou données sans préavis.

# 6" BSP SS 06060 18-30

## Spécifications techniques

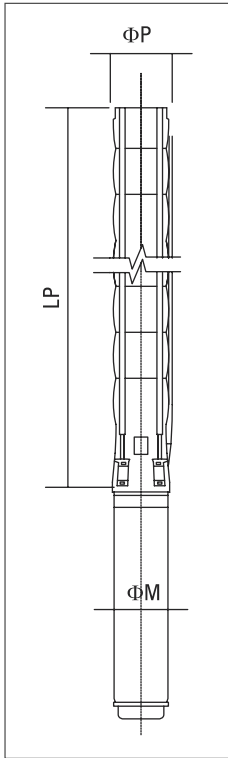

### Dimensions

Modèle	Phases	kW	HP	LP	ΦM	ΦP	Pompe poids [kg]
				[mm]	[mm]	[inch]	
BSP SS 06060/18	18	37	50	2286	142/(192)	6"	52
BSP SS 06060/19	19	37	50	2398	142/(192)	6"	55
BSP SS 06060/20	20	37	50	2510	142/(192)	6"	58
BSP SS 06060/21	21	37	50	2622	142/(192)	6"	60
BSP SS 06060/22	22	45	60	2734	142/(192)	6"	63
BSP SS 06060/23	23	45	60	2846	142/(192)	6"	65
BSP SS 06060/24	24	45	60	2958	142/(192)	6"	68
BSP SS 06060/25	25	52	70	3070	192	6"	71
BSP SS 06060/26	26	52	70	3182	192	6"	73
BSP SS 06060/27	27	52	70	3294	192	6"	76
BSP SS 06060/28	28	52	70	3406	192	6"	79
BSP SS 06060/29	29	55	75	3518	192	6"	81
BSP SS 06060/30	30	55	75	3630	192	6"	84

( ) disponible sur demande

### Tableau de performances

Modèle	Phases	kW	HP	Q=Débit								
				m³/h	0	30	36	43	51	58	65	72
				l/s	0	8,3	10	11,9	14,2	16,1	18,1	20
H=Hauteur [m]												
BSP SS 06060/18	18	37	50	266	211	198	184	169	155	137	111	
BSP SS 06060/19	19	37	50	281	222	209	194	179	164	145	117	
BSP SS 06060/20	20	37	50	296	234	220	204	188	173	153	123	
BSP SS 06060/21	21	37	50	311	246	231	215	198	181	160	129	
BSP SS 06060/22	22	45	60	326	257	242	225	207	190	168	136	
BSP SS 06060/23	23	45	60	340	269	253	235	216	199	176	142	
BSP SS 06060/24	24	45	60	355	281	264	245	226	207	183	148	
BSP SS 06060/25	25	52	70	370	293	275	256	235	216	191	154	
BSP SS 06060/26	26	52	70	385	304	285	266	245	225	198	160	
BSP SS 06060/27	27	52	70	400	316	296	276	254	233	206	166	
BSP SS 06060/28	28	52	70	414	328	307	286	264	242	214	173	
BSP SS 06060/29	29	55	75	429	339	318	296	273	250	221	179	
BSP SS 06060/30	30	55	75	444	351	329	307	282	259	229	185	

# 7" BSP SS 07075 01-22

## Courbes de performances

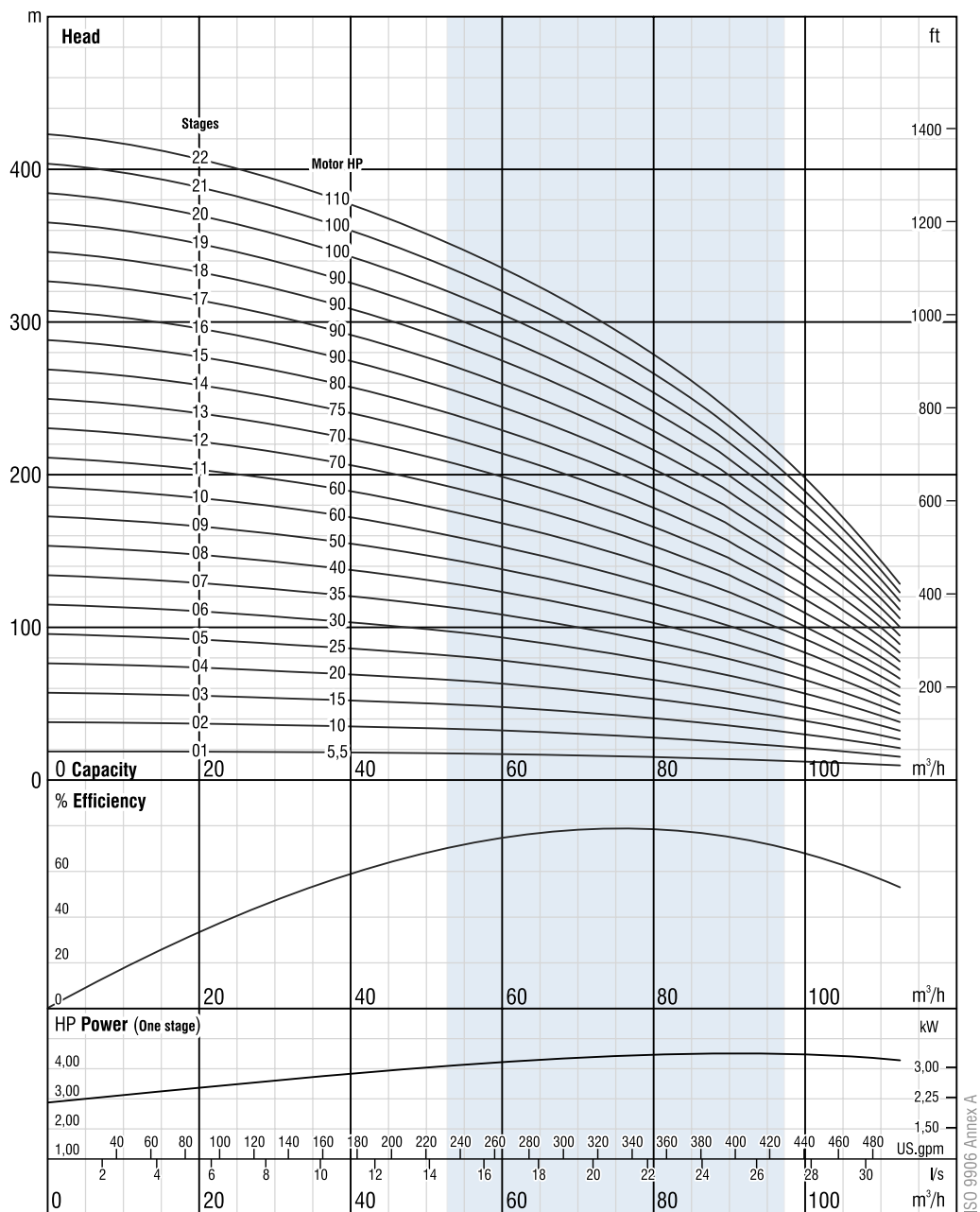

Du fait de l'amélioration continue de la conception, nous nous réservons le droit d'amender les spécifications ou données sans préavis.

# 7" BSP SS 07075 01-22

## Spécifications techniques

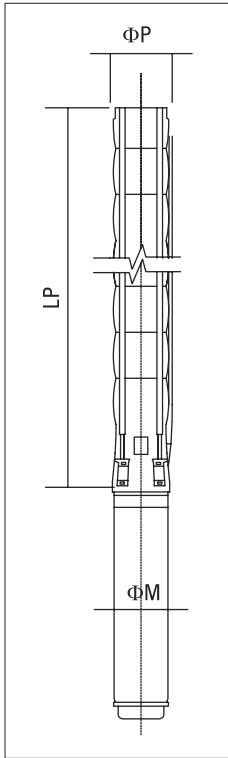

Dimensions							
Modèle	Phases	kW	HP	LP	ΦM	ΦP	Pompe poids [kg]
				[mm]	[mm]	[inch]	
BSP SS 07075/01	1	4	5,5	571	(95)/142	7"	26
BSP SS 07075/02	2	7,5	10	699	(95)/142	7"	30
BSP SS 07075/03	3	11	15	827	142	7"	34
BSP SS 07075/04	4	15	20	955	142	7"	38
BSP SS 07075/05	5	18,5	25	1083	142	7"	42
BSP SS 07075/06	6	22	30	1211	142	7"	46
BSP SS 07075/07	7	26,5	35	1339	142	7"	50
BSP SS 07075/08	8	30	40	1467	142/(192)	7"	54
BSP SS 07075/09	9	37	50	1595	142/(192)	7"	58
BSP SS 07075/10	10	37	50	1723	142/(192)	7"	62
BSP SS 07075/11	11	45	60	1851	142/(192)	7"	66
BSP SS 07075/12	12	45	60	1979	142/(192)	7"	70
BSP SS 07075/13	13	52	70	2107	192	7"	74
BSP SS 07075/14	14	52	70	2235	192	7"	78
BSP SS 07075/15	15	55	75	2363	192	7"	82
BSP SS 07075/16	16	60	80	2491	192	7"	86
BSP SS 07075/17	17	67	90	2619	192	7"	89
BSP SS 07075/18	18	67	90	2747	192	7"	93
BSP SS 07075/19	19	67	90	2875	192	7"	97
BSP SS 07075/20	20	75	100	3003	192	7"	101
BSP SS 07075/21	21	75	100	3131	192	7"	105
BSP SS 07075/22	22	81	110	3259	192/(231)	7"	109

( ) disponible sur demande

### Tableau de performances

Modèle	Phases	kW	HP	Q=Débit								
				m³/h	0	20	57,6	64,8	72	79,2	86,4	96
				l/s	0	5,5	16	18	20	22	24	26,7
H=Hauteur [m]												
BSP SS 07075/01	1	4	5,5		19	19	15	15	14	13	11	9
BSP SS 07075/02	2	7,5	10		38	37	31	29	27	25	23	19
BSP SS 07075/03	3	11	15		58	56	46	44	41	38	34	28
BSP SS 07075/04	4	15	20		77	74	62	58	55	50	45	37
BSP SS 07075/05	5	18,5	25		96	93	77	73	68	63	57	47
BSP SS 07075/06	6	22	30		115	111	93	88	82	75	68	56
BSP SS 07075/07	7	26,5	35		135	130	108	102	96	88	79	66
BSP SS 07075/08	8	30	40		154	149	124	117	109	101	91	75
BSP SS 07075/09	9	37	50		173	167	139	132	123	113	102	84
BSP SS 07075/10	10	37	50		192	186	155	146	137	126	113	94
BSP SS 07075/11	11	45	60		211	204	170	161	150	138	125	103
BSP SS 07075/12	12	45	60		231	223	186	175	164	151	136	112
BSP SS 07075/13	13	52	70		250	241	201	190	178	164	147	122
BSP SS 07075/14	14	52	70		269	260	217	205	191	176	159	131
BSP SS 07075/15	15	55	75		288	279	232	219	205	189	170	140
BSP SS 07075/16	16	60	80		307	297	247	234	219	201	181	150
BSP SS 07075/17	17	67	90		327	316	263	249	232	214	193	159
BSP SS 07075/18	18	67	90		346	334	278	263	246	226	204	169
BSP SS 07075/19	19	67	90		365	353	294	278	260	239	215	178
BSP SS 07075/20	20	75	100		384	371	309	292	273	252	227	187
BSP SS 07075/21	21	75	100		404	390	325	307	287	264	238	197
BSP SS 07075/22	22	81	110		423	409	340	322	301	277	249	206

# 7" BSP SS 07095 01-22

## Courbes de performances

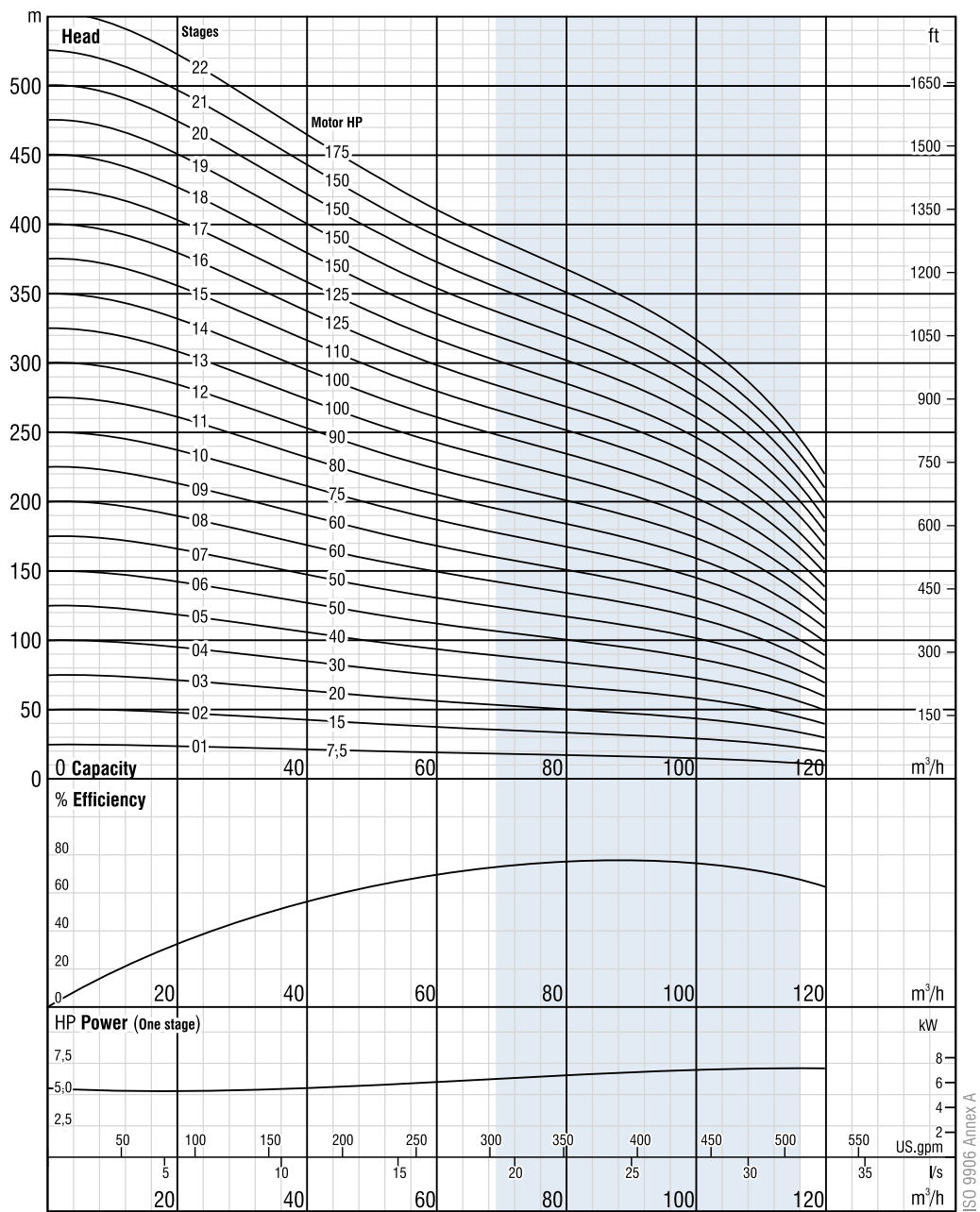

Du fait de l'amélioration continue de la conception, nous nous réservons le droit d'amender les spécifications ou données sans préavis.

# 7" BSP SS 07095 01-22

## Spécifications techniques

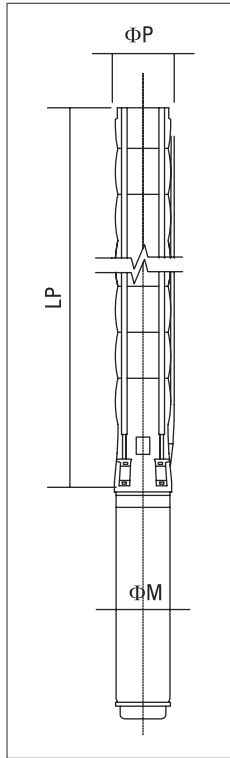

Dimensions							
Modèle	Phases	kW	HP	LP [mm]	ΦM [mm]	ΦP [inch]	Pompe poids [kg]
BSP SS 07095/01	1	5,5	7,5	571	(95)/142	7"	26
BSP SS 07095/02	2	11	15	699	142	7"	30
BSP SS 07095/03	3	15	20	827	142	7"	34
BSP SS 07095/04	4	22	30	955	142	7"	38
BSP SS 07095/05	5	30	40	1083	142/(192)	7"	42
BSP SS 07095/06	6	37	50	1211	142/(192)	7"	46
BSP SS 07095/07	7	37	50	1339	142/(192)	7"	50
BSP SS 07095/08	8	45	60	1467	142/(192)	7"	54
BSP SS 07095/09	9	52	60	1595	142/(192)	7"	58
BSP SS 07095/10	10	55	75	1723	192	7"	62
BSP SS 07095/11	11	60	80	1851	192	7"	66
BSP SS 07095/12	12	67	90	1979	192	7"	70
BSP SS 07095/13	13	75	100	2107	192	7"	74
BSP SS 07095/14	14	75	100	2235	192	7"	78
BSP SS 07095/15	15	81	110	2363	192/(231)	7"	82
BSP SS 07095/16	16	92	125	2491	192/(231)	7"	86
BSP SS 07095/17	17	92	125	2619	192/(231)	7"	90
BSP SS 07095/18	18	110	150	2747	192/(231)	7"	94
BSP SS 07095/19	19	110	150	2875	192/(231)	7"	98
BSP SS 07095/20	20	110	150	3003	192/(231)	7"	102
BSP SS 07095/21	21	110	150	3131	192/(231)	7"	106
BSP SS 07095/22	22	129	175	3259	231	7"	110

( ) disponible sur demande

## Tableau de performances

Modèle	Phases	kW	HP	Q=Débit									
				m³/h	0	20	40	60	70	80	90	100	110
				l/s	0	5,6	11,1	16,7	19,4	22,2	25	27,8	30,6
H=Hauteur [m]													
BSP SS 07095/01	1	5,5	7,5		25	24	21	19	18	17	16	15	13
BSP SS 07095/02	2	11	15		50	47	42	37	35	34	32	29	25
BSP SS 07095/03	3	15	20		75	71	63	56	53	51	48	44	38
BSP SS 07095/04	4	22	30		100	95	84	75	71	67	64	58	51
BSP SS 07095/05	5	30	40		125	119	105	93	89	84	79	73	63
BSP SS 07095/06	6	37	50		150	142	126	112	106	101	95	88	76
BSP SS 07095/07	7	37	50		175	166	148	131	124	118	111	102	89
BSP SS 07095/08	8	45	60		200	190	169	149	142	135	127	117	101
BSP SS 07095/09	9	52	60		225	214	190	168	159	152	143	131	114
BSP SS 07095/10	10	55	75		250	237	211	187	177	168	159	146	127
BSP SS 07095/11	11	60	80		275	261	232	205	195	185	175	161	139
BSP SS 07095/12	12	67	90		300	285	253	224	213	202	191	175	152
BSP SS 07095/13	13	75	100		325	309	274	243	230	219	206	190	165
BSP SS 07095/14	14	75	100		350	332	295	261	248	236	222	204	177
BSP SS 07095/15	15	81	110		375	356	316	280	266	253	238	219	190
BSP SS 07095/16	16	92	125		400	380	337	299	283	269	254	234	203
BSP SS 07095/17	17	92	125		425	404	358	317	301	286	270	248	215
BSP SS 07095/18	18	110	150		450	427	379	336	319	303	286	263	228
BSP SS 07095/19	19	110	150		475	451	401	355	337	320	302	277	241
BSP SS 07095/20	20	110	150		500	475	422	373	354	337	318	292	253
BSP SS 07095/21	21	110	150		525	499	443	392	372	354	333	307	266
BSP SS 07095/22	22	129	175		550	522	464	411	390	370	349	321	279

# 7" BSP SS 07105 01-20

## Courbes de performances

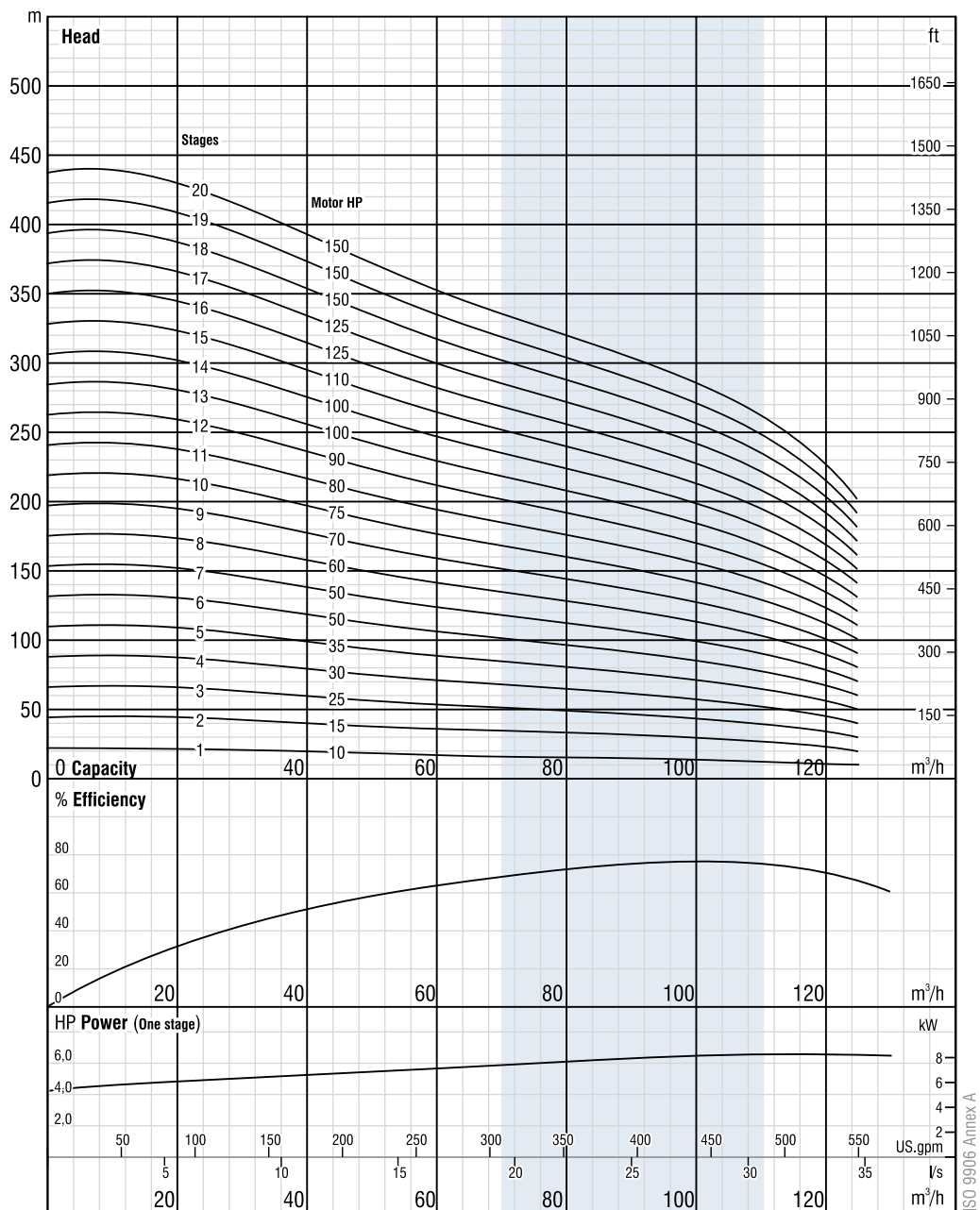

Du fait de l'amélioration continue de la conception, nous nous réservons le droit d'amender les spécifications ou données sans préavis.



# 7" BSP SS 07105 01-20

## Spécifications techniques

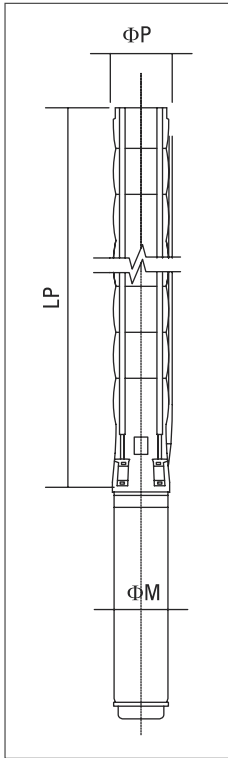

### Dimensions

Modèle	Phases	kW	HP	LP [mm]	ΦM [mm]	ΦP [inch]	Pompe poids [kg]
BSP SS 07105/01	1	7,5	10	571	(95)/142	7"	26
BSP SS 07105/02	2	11	15	699	142	7"	30
BSP SS 07105/03	3	18,5	25	827	142	7"	34
BSP SS 07105/04	4	22	30	955	142	7"	38
BSP SS 07105/05	5	26,5	35	1083	142	7"	42
BSP SS 07105/06	6	37	50	1211	142/(192)	7"	46
BSP SS 07105/07	7	37	50	1339	142/(192)	7"	50
BSP SS 07105/08	8	45	60	1467	142/(192)	7"	54
BSP SS 07105/09	9	52	70	1595	192	7"	58
BSP SS 07105/10	10	55	75	1723	192	7"	62
BSP SS 07105/11	11	60	80	1851	192	7"	66
BSP SS 07105/12	12	67	90	1979	192	7"	70
BSP SS 07105/13	13	75	100	2107	192	7"	74
BSP SS 07105/14	14	75	100	2235	192	7"	78
BSP SS 07105/15	15	81	110	2363	192/(231)	7"	82
BSP SS 07105/16	16	92	125	2491	192/(231)	7"	86
BSP SS 07105/17	17	92	125	2619	192/(231)	7"	90
BSP SS 07105/18	18	110	150	2747	192/(231)	7"	94
BSP SS 07105/19	19	110	150	2875	192/(231)	7"	98
BSP SS 07105/20	20	110	150	3003	192/(231)	7"	102

( ) disponible sur demande

### Tableau de performances

Modèle	Phases	kW	HP	Q=Débit								
				m³/h	0	20	40	70	90	100	110	125
				l/s	0	5,6	11,1	19,4	25	27,8	30,6	34,7
H=Hauteur [m]												
BSP SS 07105/01	1	7,5	10	22	21	20	17	15	14	13	10	
BSP SS 07105/02	2	11	15	44	43	39	33	30	28	26	20	
BSP SS 07105/03	3	18,5	25	65	64	59	50	45	43	39	30	
BSP SS 07105/04	4	22	30	87	86	78	67	61	57	52	40	
BSP SS 07105/05	5	26,5	35	109	107	98	84	76	71	65	50	
BSP SS 07105/06	6	37	50	131	129	117	100	91	85	78	61	
BSP SS 07105/07	7	37	50	153	150	137	117	106	100	91	71	
BSP SS 07105/08	8	45	60	175	171	157	134	121	114	104	81	
BSP SS 07105/09	9	52	70	196	193	176	151	136	128	117	91	
BSP SS 07105/10	10	55	75	218	214	196	167	152	142	130	101	
BSP SS 07105/11	11	60	80	240	236	215	184	167	157	143	111	
BSP SS 07105/12	12	67	90	262	257	235	201	182	171	156	121	
BSP SS 07105/13	13	75	100	284	279	255	217	197	185	169	131	
BSP SS 07105/14	14	75	100	305	300	274	234	212	199	182	141	
BSP SS 07105/15	15	81	110	327	321	294	251	227	214	195	151	
BSP SS 07105/16	16	92	125	349	343	313	268	242	228	208	161	
BSP SS 07105/17	17	92	125	371	364	333	284	258	242	221	171	
BSP SS 07105/18	18	110	150	393	386	352	301	273	256	234	182	
BSP SS 07105/19	19	110	150	415	407	372	318	288	271	247	192	
BSP SS 07105/20	20	110	150	436	429	392	334	303	285	260	202	

# 8" BSP SS 08110 01-20

## Courbes de performances

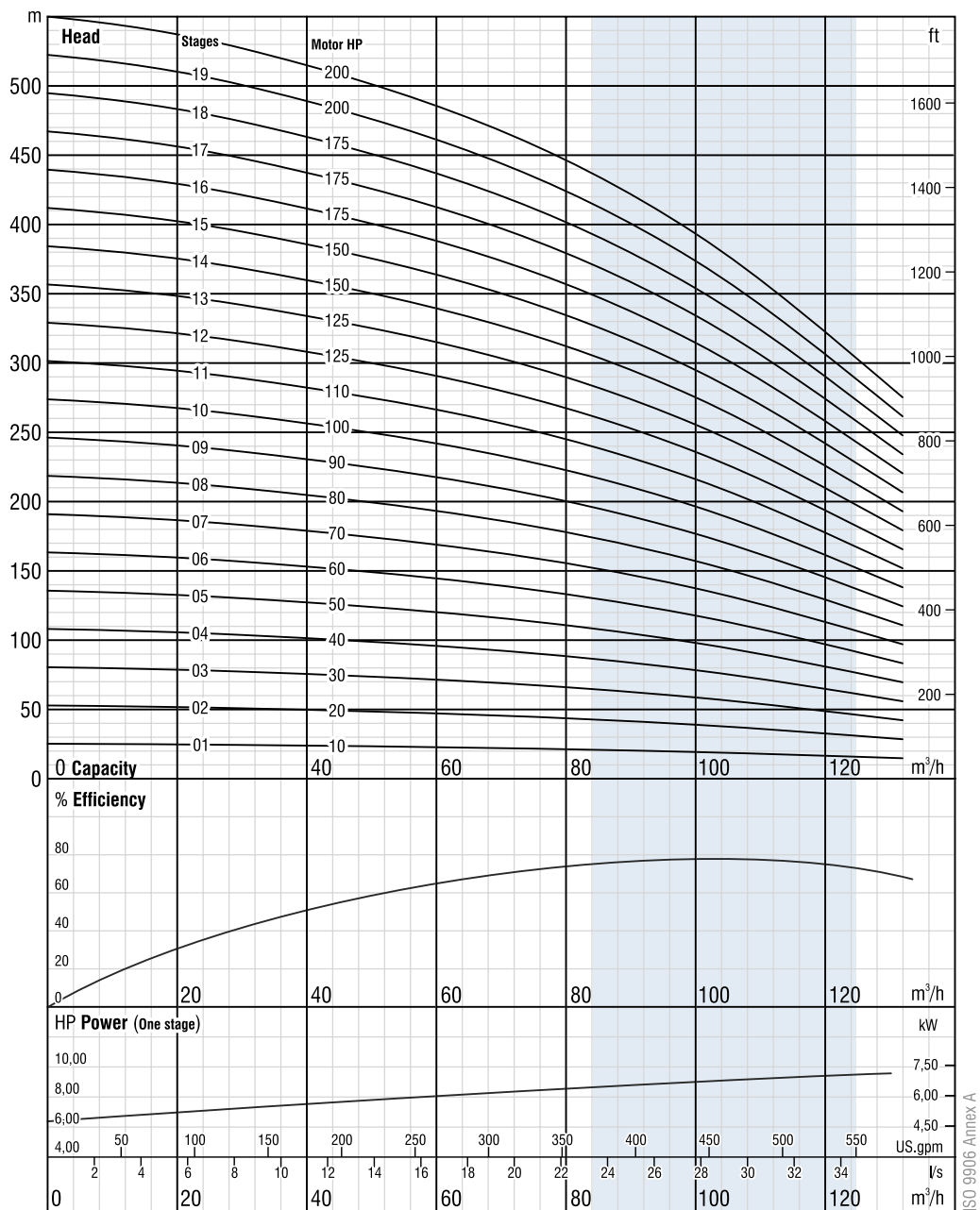

Du fait de l'amélioration continue de la conception, nous nous réservons le droit d'amender les spécifications ou données sans préavis.

# 8" BSP SS 08110 01-20

## Spécifications techniques

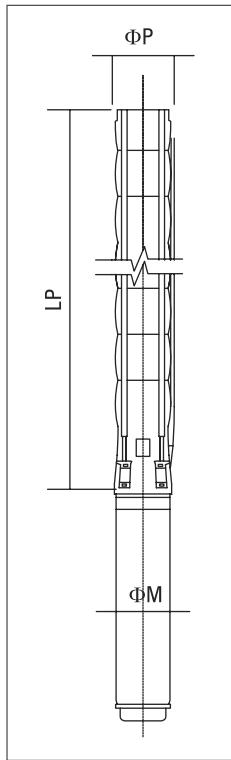

Dimensions							
Modèle	Phases	kW	HP	LP [mm]	ΦM [mm]	ΦP [inch]	Pompe poids [kg]
BSP SS 08110/01	1	7,5	10	686	(95)/142	8"	32
BSP SS 08110/02	2	15	20	842	142	8"	38
BSP SS 08110/03	3	22	30	997	142	8"	45
BSP SS 08110/04	4	30	40	1153	(142)/192	8"	51
BSP SS 08110/05	5	37	50	1309	(142)/192	8"	57
BSP SS 08110/06	6	45	60	1465	(142)/192	8"	64
BSP SS 08110/07	7	52	70	1620	192	8"	70
BSP SS 08110/08	8	60	80	1776	192	8"	76
BSP SS 08110/09	9	67	90	1932	192	8"	83
BSP SS 08110/10	10	75	100	2087	192	8"	89
BSP SS 08110/11	11	81	110	2243	192/(231)	8"	95
BSP SS 08110/12	12	92	125	2399	192/(231)	8"	101
BSP SS 08110/13 **	13	92	125	2554	192/(231)	8"	108
BSP SS 08110/14 **	14	110	150	2710	192/(231)	8"	114
BSP SS 08110/15 **	15	110	150	2866	192/(231)	8"	120
BSP SS 08110/16 **	16	129	175	3022	231	8"	127
BSP SS 08110/17 **	17	129	175	3177	231	8"	133
BSP SS 08110/18 **	18	129	175	3333	231	8"	139
BSP SS 08110/19 **	19	147	200	3489	231	8"	145
BSP SS 08110/20 **	20	147	200	3644	231	8"	152

\*\* Modèles produits avec huit tirants  
( ) disponible sur demande

### Tableau de performances

Modèle	Phases	kW	HP	Q=Débit									
				m³/h	0	25	70	80	90	100	110	120	130
				l/s	0	6,9	19,4	22,2	25	27,8	30,6	33,3	36,1
H=Hauteur [m]													
BSP SS 08110/01	1	7,5	10	27	27	22	22	21	20	18	16	14	
BSP SS 08110/02	2	15	20	55	53	45	43	42	39	36	33	28	
BSP SS 08110/03	3	22	30	82	80	67	65	63	59	55	49	43	
BSP SS 08110/04	4	30	40	110	107	90	87	83	79	73	66	57	
BSP SS 08110/05	5	37	50	137	133	112	109	104	98	91	82	71	
BSP SS 08110/06	6	45	60	165	160	135	130	125	118	109	99	85	
BSP SS 08110/07	7	52	70	192	187	157	152	146	138	128	115	99	
BSP SS 08110/08	8	60	80	220	213	180	174	167	158	146	131	114	
BSP SS 08110/09	9	67	90	247	240	202	196	188	177	164	148	128	
BSP SS 08110/10	10	75	100	274	267	225	217	208	197	182	164	142	
BSP SS 08110/11	11	81	110	302	293	247	239	229	217	200	181	156	
BSP SS 08110/12	12	92	125	329	320	270	261	250	236	219	197	170	
BSP SS 08110/13 **	13	92	125	357	347	292	283	271	256	237	214	185	
BSP SS 08110/14 **	14	110	150	384	373	315	304	292	276	255	230	199	
BSP SS 08110/15 **	15	110	150	412	400	337	326	313	295	273	246	213	
BSP SS 08110/16 **	16	129	175	439	427	360	348	333	315	292	263	227	
BSP SS 08110/17 **	17	129	175	467	453	382	370	354	335	310	279	241	
BSP SS 08110/18 **	18	129	175	494	480	405	391	375	355	328	296	256	
BSP SS 08110/19 **	19	147	200	521	507	427	413	396	374	346	312	270	
BSP SS 08110/20 **	20	147	200	549	533	450	435	417	394	364	329	284	

\*\* Modèles produits avec huit tirants

# 8" BSP SS 08125 01-13

## Courbes de performances

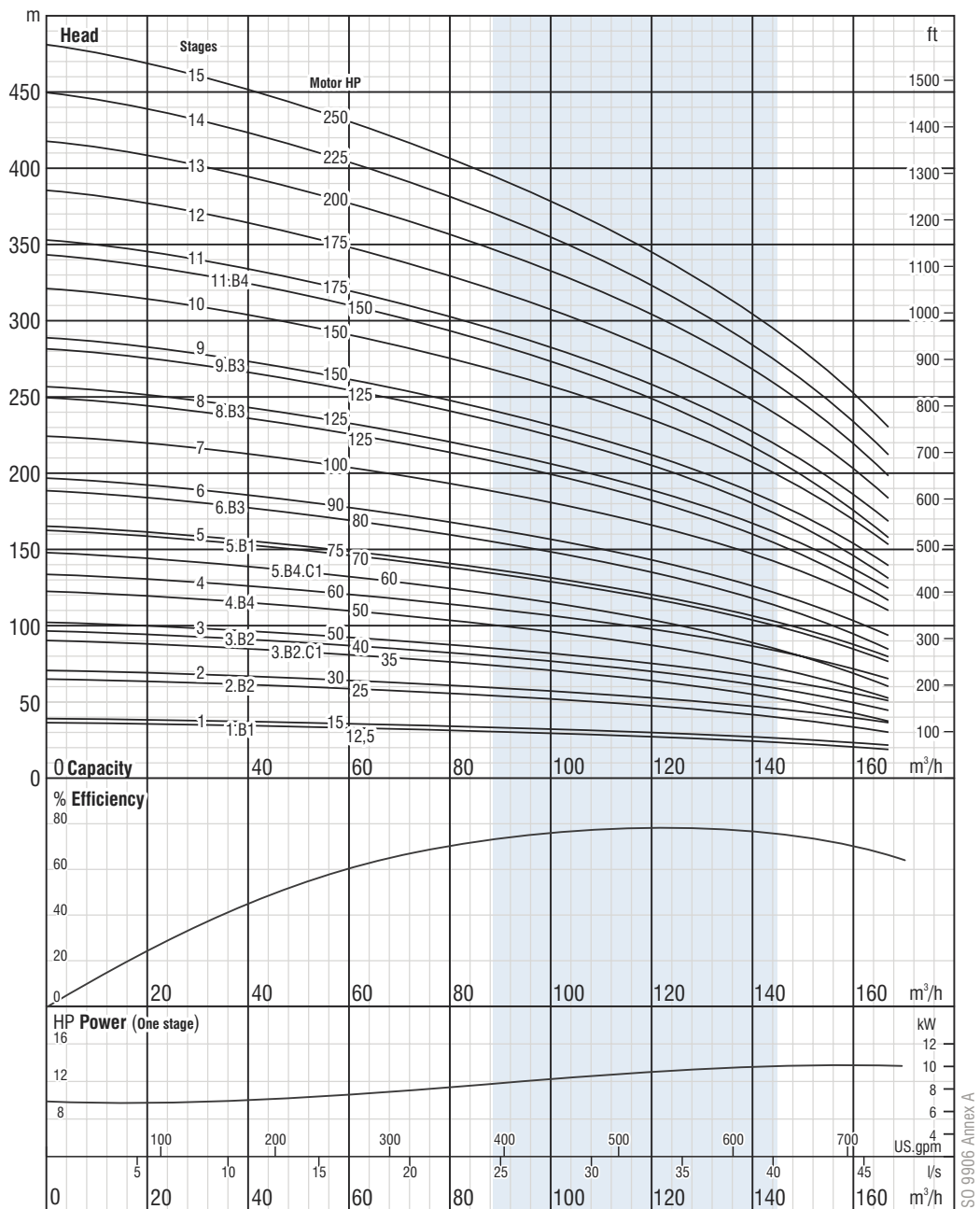

Du fait de l'amélioration continue de la conception, nous nous réservons le droit d'amender les spécifications ou données sans préavis.

# 8" BSP SS 08125 01-13

## Spécifications techniques

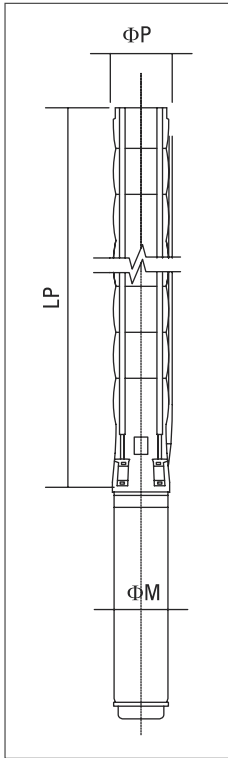

### Dimensions

Modèle	Phases	kW	HP	LP [mm]	ΦM [mm]	ΦP [inch]	Pompe poids [kg]
BSP SS 08125/01	1	11	15	686	142	8"	32
BSP SS 08125/02	2	22	30	842	142	8"	39
BSP SS 08125/03	3	37	50	997	(142)/192	8"	45
BSP SS 08125/04	4	45	60	1153	(142)/192	8"	52
BSP SS 08125/05	5	55	75	1309	192	8"	58
BSP SS 08125/06	6	67	90	1465	192	8"	65
BSP SS 08125/07	7	75	100	1620	192	8"	71
BSP SS 08125/08	8	92	125	1776	192/(231)	8"	78
BSP SS 08125/09	9	110	150	1932	192/(231)	8"	84
BSP SS 08125/10	10	110	150	2087	192/(231)	8"	91
BSP SS 08125/11	11	129	175	2243	231	8"	97
BSP SS 08125/12	12	129	175	2399	231	8"	104
BSP SS 08125/13 **	13	147	200	2554	231	8"	110
BSP SS 08125/14 **	14	166	225	2710	231	213	117
BSP SS 08125/15 **	15	185	250	2866	231	213	123

\*\* Modèles produits avec huit tirants  
( ) disponible sur demande

### Tableau de performances

Modèle	Phases	kW	HP	Q=Débit									
				m³/h	0	40	90	120	130	140	150	160	170
				l/s	0	11,1	25	33,3	36,1	38,9	41,7	44,4	47,2
				H=Hauteur [m]									
BSP SS 08125/01	1	11	15		32	30	26	23	22	20	18	16	14
BSP SS 08125/02	2	22	30		64	60	52	46	43	40	37	33	28
BSP SS 08125/03	3	37	50		96	91	79	69	65	60	55	49	42
BSP SS 08125/04	4	45	60		128	121	105	92	86	80	73	65	56
BSP SS 08125/05	5	55	75		160	151	131	115	108	100	92	81	70
BSP SS 08125/06	6	67	90		192	181	157	138	130	120	110	98	83
BSP SS 08125/07	7	75	100		225	211	183	161	151	140	128	114	97
BSP SS 08125/08	8	92	125		257	241	210	184	173	161	146	130	111
BSP SS 08125/09	9	110	150		289	272	236	207	194	181	165	146	125
BSP SS 08125/10	10	110	150		321	302	262	230	216	201	183	163	139
BSP SS 08125/11	11	129	175		353	332	288	253	238	221	201	179	153
BSP SS 08125/12	12	129	175		385	362	315	275	259	241	220	195	167
BSP SS 08125/13 **	13	147	200		417	392	341	298	281	261	238	211	181
BSP SS 08125/14 **	14	166	225		449	422	367	321	302	281	256	228	195
BSP SS 08125/15 **	15	185	250		481	453	393	344	324	301	275	244	209

\*\* Modèles produits avec huit tirants

# 8" BSP SS 08160 01-06

## Courbes de performances

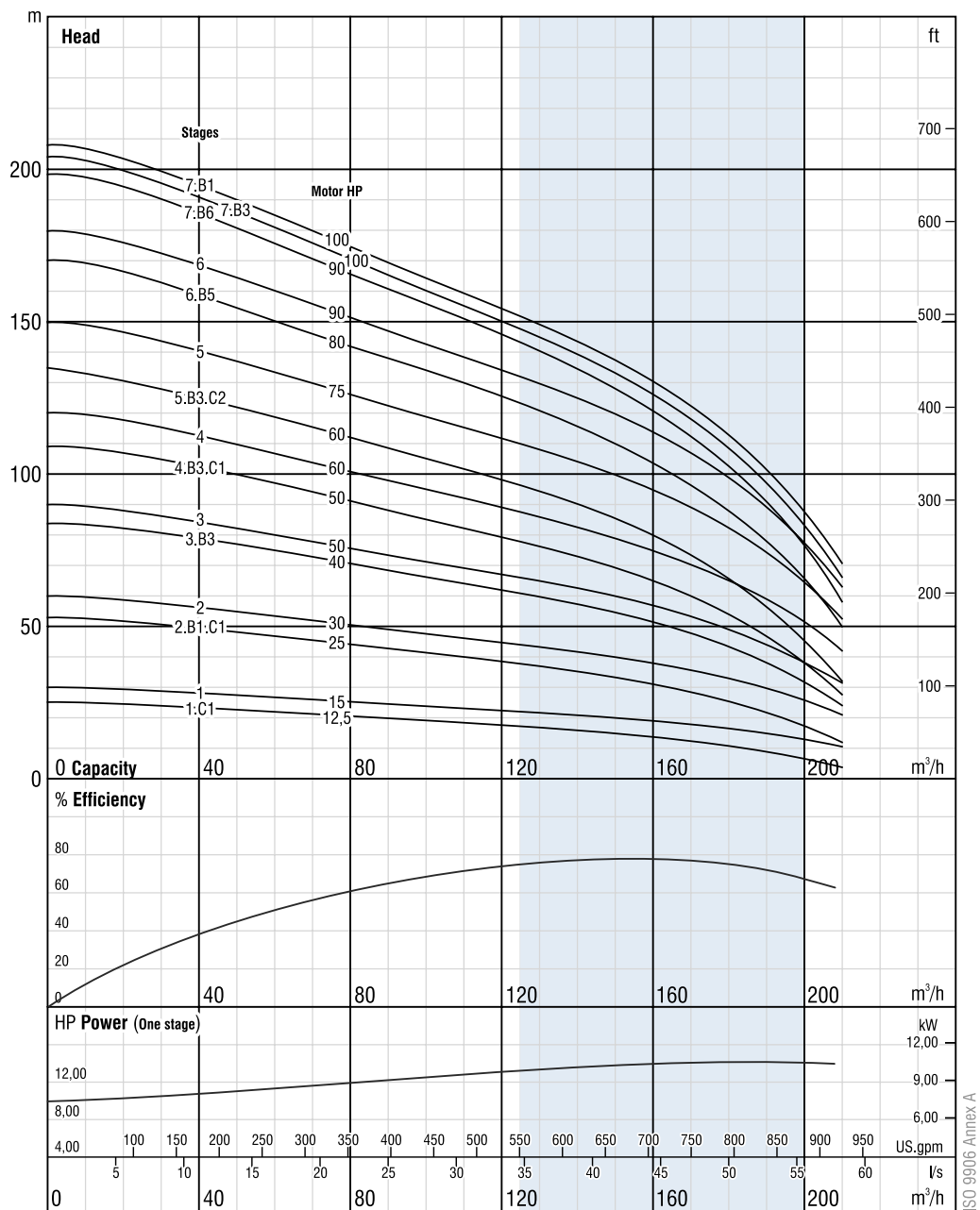

Du fait de l'amélioration continue de la conception, nous nous réservons le droit d'amender les spécifications ou données sans préavis.

# 8" BSP SS 08160 01-06

## Spécifications techniques

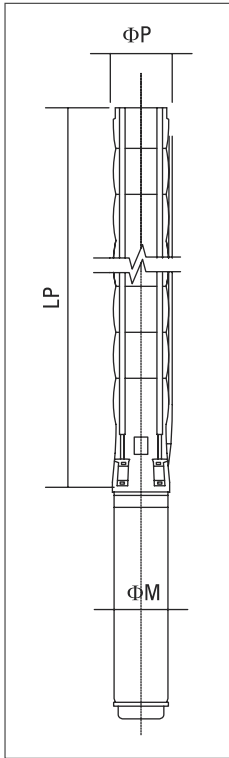

### Dimensions

Modèle	Phases	kW	HP	LP [mm]	ΦM [mm]	ΦP [inch]	Pompe poids [kg]
BSP SS 08160/01	1	11	15	686	142	8"	34
BSP SS 08160/02	2	22	30	842	142	8"	40
BSP SS 08160/03	3	37	50	997	(142)/192	8"	47
BSP SS 08160/04	4	45	60	1153	(142)/192	8"	53
BSP SS 08160/05	5	55	75	1309	192	8"	60
BSP SS 08160/06	6	67	90	1465	192	8"	66

( ) disponible sur demande

### Tableau de performances

Modèle	Phases	kW	HP	Q=Débit								
				m³/h	0	80	100	120	140	160	180	200
				l/s	0	22,2	27,8	33,3	38,9	44,4	50	55,6
H=Hauteur [m]												
BSP SS 08160/01	1	11	15	30	25	24	22	21	19	16	13	
BSP SS 08160/02	2	22	30	60	50	47	45	41	38	33	26	
BSP SS 08160/03	3	37	50	90	76	71	67	62	57	49	39	
BSP SS 08160/04	4	45	60	119	101	95	89	83	75	65	52	
BSP SS 08160/05	5	55	75	149	126	119	111	104	94	81	65	
BSP SS 08160/06	6	67	90	179	151	142	134	124	113	98	78	

# 8" BSP SS 08160 7-13

## Courbes de performances

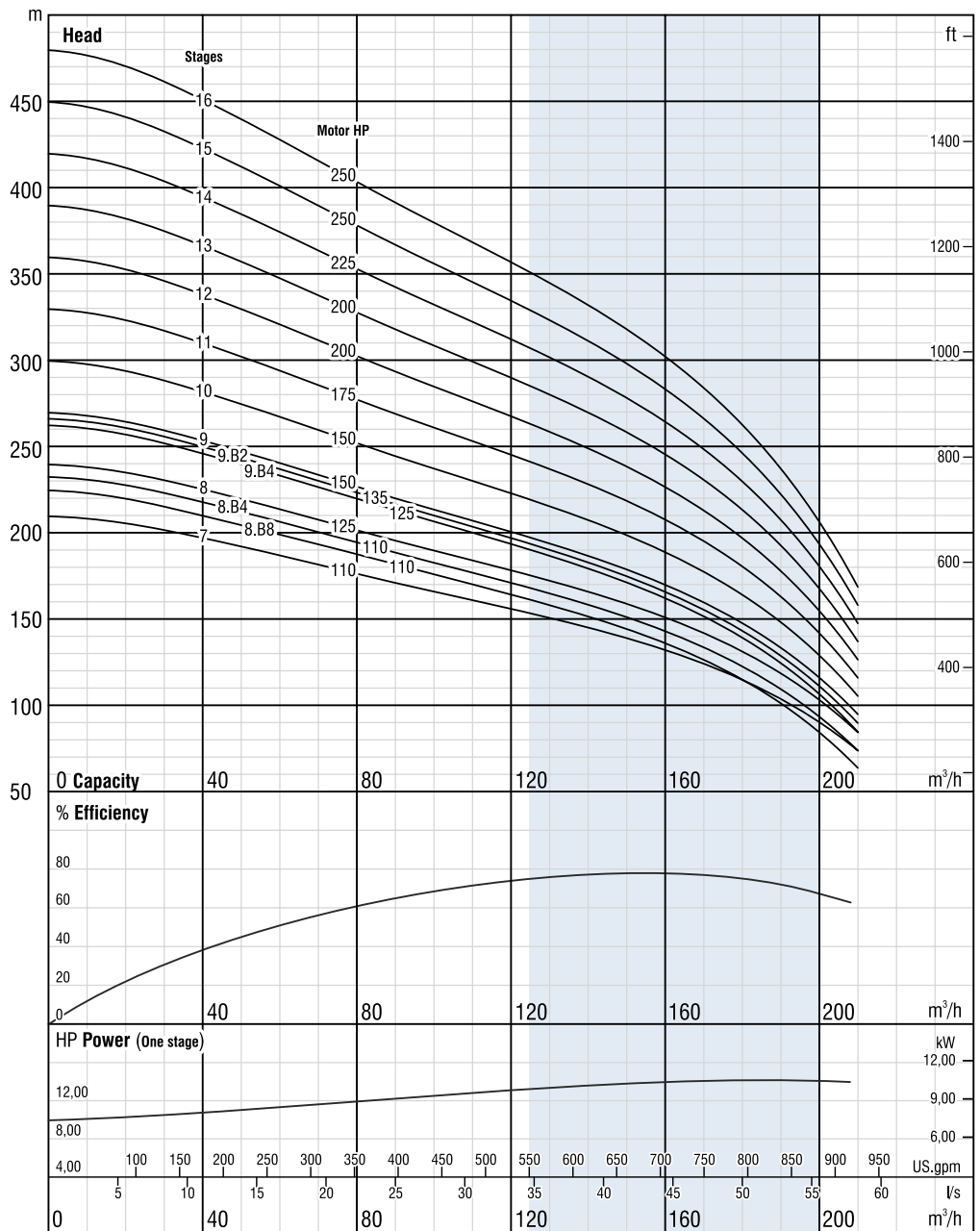

Du fait de l'amélioration continue de la conception, nous nous réservons le droit d'amender les spécifications ou données sans préavis.

ISO 9906 Annex A



# 8" BSP SS 08160 7-13

## Spécifications techniques

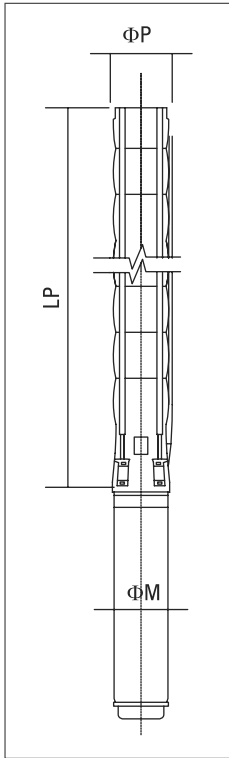

### Dimensions

Modèle	Phases	kW	HP	LP [mm]	ΦM [mm]	ΦP [inch]	Pompe poids [kg]
BSP SS 08160/07	7	81	110	1620	192/(231)	8"	73
BSP SS 08160/08	8	92	125	1776	192/(231)	8"	79
BSP SS 08160/09	9	110	150	1932	192/(231)	8"	86
BSP SS 08160/10	10	110	150	2087	192/(231)	8"	92
BSP SS 08160/11	11	129	175	2243	231	8"	99
BSP SS 08160/12	12	147	200	2399	231	8"	105
BSP SS 08160/13 **	13	147	200	2554	231	8"	112

\*\* Modèles produits avec huit tirants  
( ) disponible sur demande

### Tableau de performances

Modèle	Phases	kW	HP	Q=Débit								
				m³/h	0	80	100	120	140	160	180	200
				l/s	0	22,2	27,8	33,3	38,9	44,4	50	55,6
				H=Hauteur [m]								
BSP SS 08160/07	7	81	110	210	177	261	156	145	132	104	91	
BSP SS 08160/08	8	92	125	239	202	332	178	166	151	120	103	
BSP SS 08160/09	9	110	150	272	227	176	200	187	170	148	117	
BSP SS 08160/10	10	110	150	301	252	183	223	207	188	162	128	
BSP SS 08160/11	11	129	175	329	277	190	245	228	207	182	143	
BSP SS 08160/12	12	147	200	362	303	206	267	249	226	193	155	
BSP SS 08160/13 **	13	147	200	393	328	210	290	270	245	213	167	

\*\* Modèles produits avec huit tirants

# 10" BSP SS 10210 01-12

## Courbes de performances

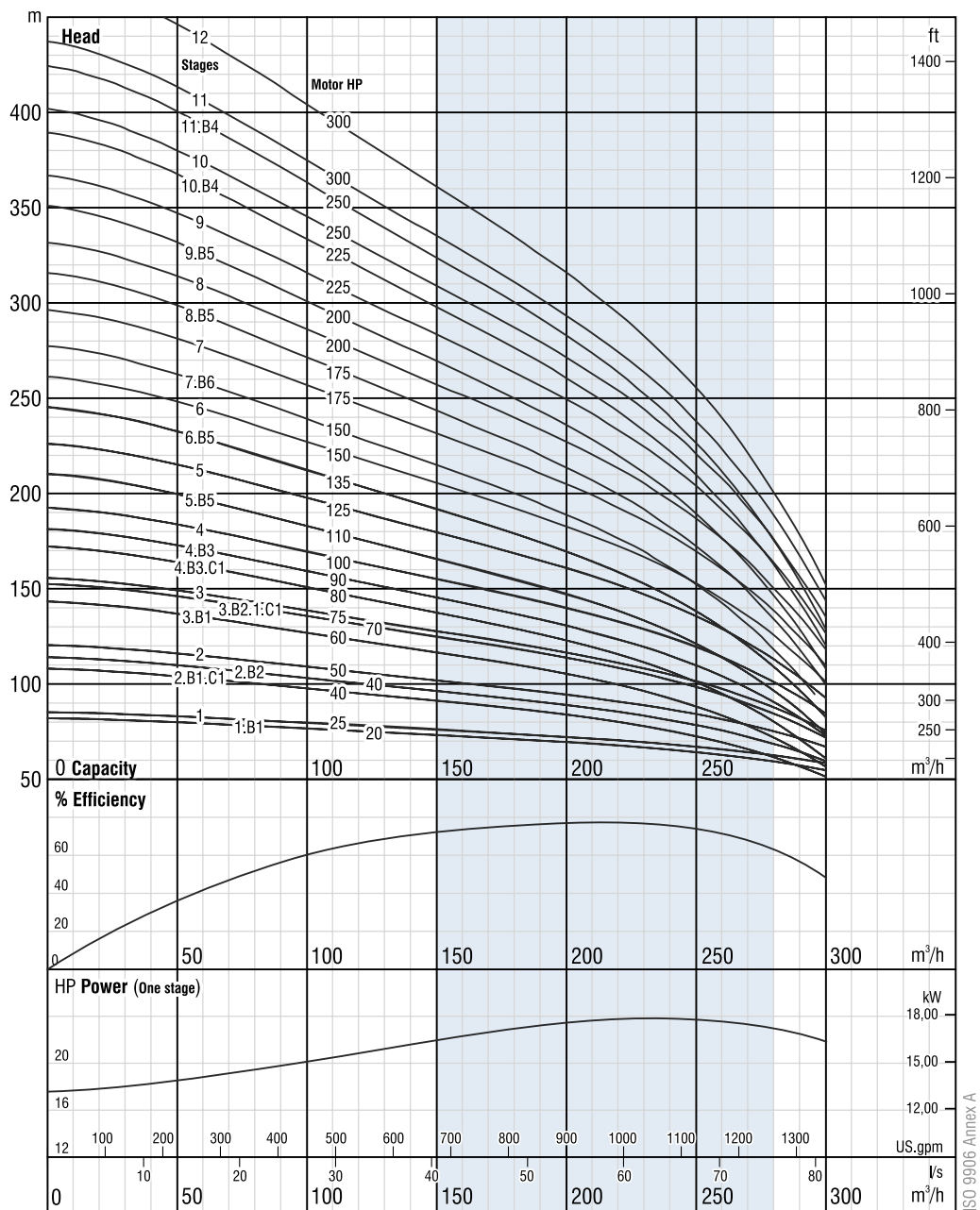

Du fait de l'amélioration continue de la conception, nous nous réservons le droit d'amender les spécifications ou données sans préavis.

ISO 9906 Annex A

# 10" BSP SS 10210 01-12

## Spécifications techniques

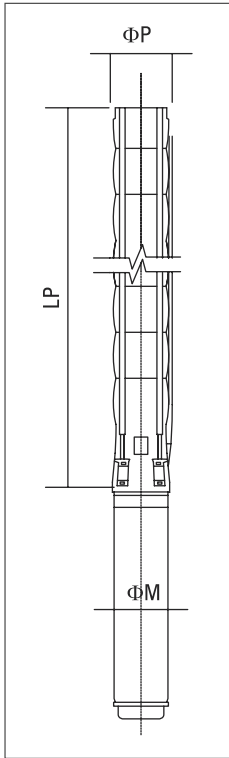

Dimensions							
Modèle	Phases	kW	HP	LP [mm]	ΦM [mm]	ΦP [inch]	Pompe poids [kg]
BSP SS 10210/01	1	18,5	25	794	142	10"	44
BSP SS 10210/02	2	37	50	970	(142)/192	10"	55
BSP SS 10210/03	3	55	75	1147	192	10"	66
BSP SS 10210/04	4	75	100	1323	192	10"	76
BSP SS 10210/05	5	92	125	1499	192/(231)	10"	87
BSP SS 10210/06	6	110	150	1675	192/(231)	10"	98
BSP SS 10210/07	7	129	175	1851	231	10"	109
BSP SS 10210/08**	8	150	200	2028	231	10"	119
BSP SS 10210/09**	9	166	225	2204	231	10"	130
BSP SS 10210/10**	10	185	250	2380	231	10"	141
BSP SS 10210/11**	11	220	300	2556	231	10"	152
BSP SS 10210/12**	12	220	300	2732	286	10"	162

\*\* Modèles produits avec huit tirants  
( ) disponible sur demande

### Tableau de performances

Modèle	Phases	kW	HP	Q=Débit									
				m³/h	0	100	140	180	200	220	240	260	290
				l/s	0	27,8	38,9	50	55,6	61,1	66,7	72,2	80,6
H=Hauteur [m]													
BSP SS 10210/01	1	18,5	25	40	33	30	27	25	23	21	18	12	
BSP SS 10210/02	2	37	50	79	66	60	53	50	46	41	35	24	
BSP SS 10210/03	3	55	75	119	100	90	80	75	69	62	53	36	
BSP SS 10210/04	4	75	100	160	135	121	108	101	93	83	72	49	
BSP SS 10210/05	5	92	125	198	166	150	133	125	115	103	89	60	
BSP SS 10210/06	6	110	150	238	199	180	160	149	138	124	106	72	
BSP SS 10210/07	7	129	175	277	233	210	187	174	161	144	124	84	
BSP SS 10210/08**	8	150	200	317	266	240	213	199	183	165	142	96	
BSP SS 10210/09**	9	166	225	356	299	270	240	224	206	185	160	108	
BSP SS 10210/10**	10	185	250	396	332	300	267	249	229	206	177	120	
BSP SS 10210/11**	11	220	300	436	366	330	293	274	252	227	195	132	
BSP SS 10210/12**	12	220	300	475	399	359	320	299	275	247	213	144	

\*\* Modèles produits avec huit tirants



## **EBARA Pompes Europe S.p.A.**

Via Torri di Confine 2/1 int. C  
36053 Gambellara (Vicenza), Italia  
Tel. +39 0444 706811  
Fax +39 0444 405811  
ebarapumps.epe@ebara.com  
www.ebaraeurope.com

## **EBARA Corporation**

11-1, Haneda Asahi-cho, Ota-ku,  
Tokyo 144-8510  
Giappone  
Tel. +81 3 6275 7598  
Fax +81 3 5736 3193  
www.ebara.com

